

## ПОДШИПНИКИ, РОЛИКИ, ИГЛЫ И ШАРИКИ BEARINGS, ROLLERS, NEEDLES AND BALLS

Обозначение Designation		подгруппы, где приме- няется Subgroup No.	Количество на подгруппу Qty per subgroup			Размеры, мм Dimensions, mm			Наименование Description
По чертежам УАЗ To УАЗ drawings	По ГОСТ или ГПЗ To ГОСТ or ГПЗ		УАЗ- 31519	УАЗ- 315195	УАЗ- 315143	d	D	B	
1	2	3	4	5	6	7	8	9	10

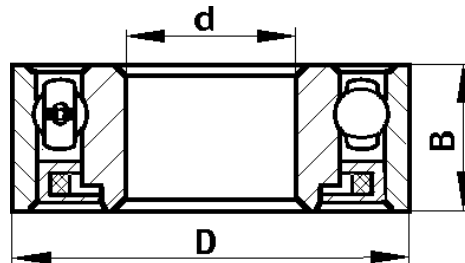

60203-A  
60203-K+

1005 1 - - 17 40 12

Шариковый радиальный  
однорядный с защитной  
шайбой  
Single-row radial ball bearing  
with protective washer

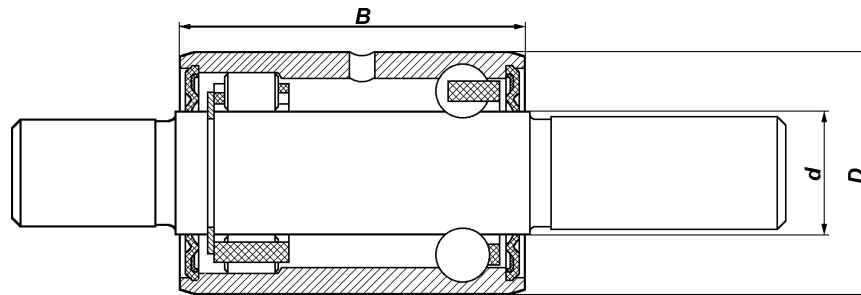

406.1307027  
406.1307027-01+

6-5HP17124EC30  
6-5HP17124EC30  
6-5HP17124E.P6Q6

1307 1 - - 19,5 38 55  
- 1 -  
- 1 -

Шарико-роликовый  
радиальный  
Radial ball bearing

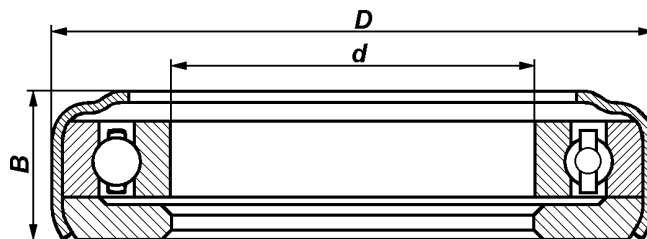

3160-1601182

В-6-520110АКС30Ш

1601 1 - 1 50 82 20

Шариковый радиально-  
упорный однорядный  
Single-row radial-thrust ball  
bearing

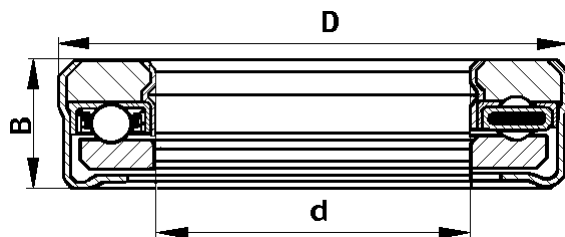

31605-1601182

360710C9

1601 - 1 - 52,388 84,5 20,7

Шариковый упорный  
однорядный в защитном  
кожухе  
Single-row thrust ball bearing  
in protective housing

1	2	3	4	5	6	7	8	9	10
---	---	---	---	---	---	---	---	---	----

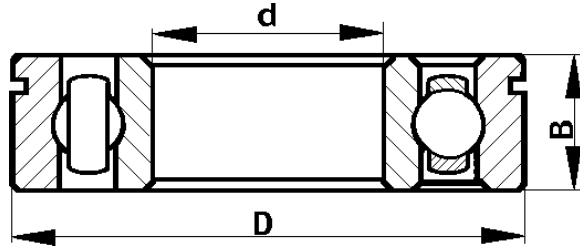

31605-1701032

1701 1 1 1 35 80 21

Шариковый радиальный  
однорядный с канавкой для  
стопорной шайбы на  
наружном кольце  
Single-row radial ball bearing  
with groove in outer race for  
lock washer

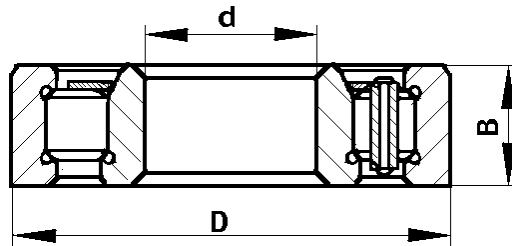

452-1802092

42305AE  
6-42305AE+

1701 1 1 1 25 62 17

Роликовый радиальный  
однорядный с внутренним  
кольцом  
Single-row radial roller bearing  
with inner race

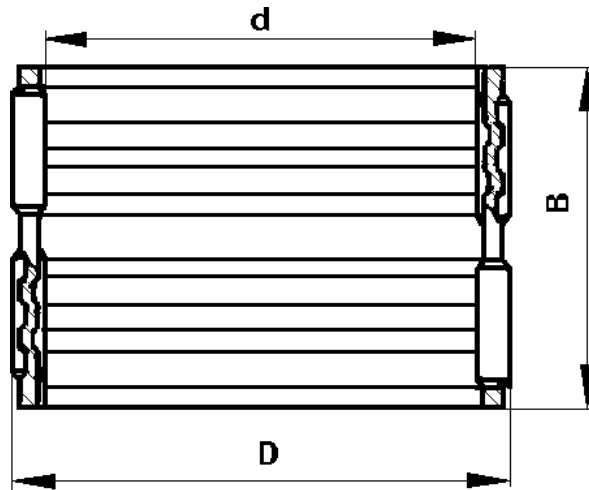

31605-1701137  
31605-1701136

3KK 37\*42\*35E  
5KK 45\*50\*39E

1701 2 2 2 37 42 39  
1701 2 2 2 45 50 35  
1801

Роликовый игольчатый  
двухрядный без колец  
Double-row needle roller  
bearing without races

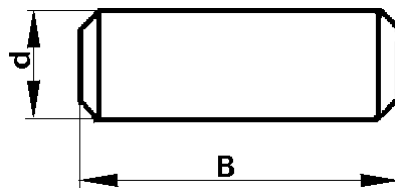

20-1701182

1701 14 14 14 5,5 - 15,8

Ролик переднего подшип-  
ника вторичного вала  
коробки передач  
Gearbox output shaft front  
bearing roller

1	2	3	4	5	6	7	8	9	10
---	---	---	---	---	---	---	---	---	----

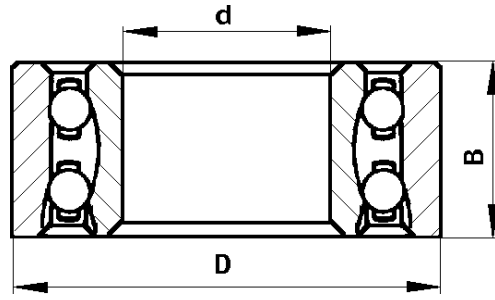

452-1701190

3056207K

1701 1 1 1 35 72 27

Шариковый радиально-упорный двухрядный  
Double-row radial-thrust ball bearing

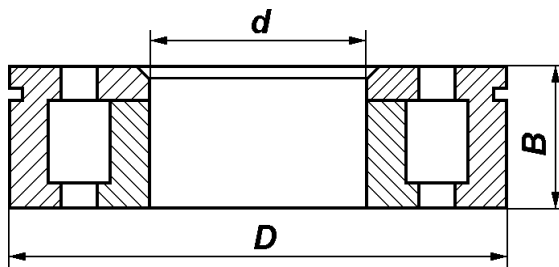

31605-1802082

1701 1 1 1 30 72 19  
1801

Роликовый радиальный с канавкой для стопорной шайбы на наружном кольце  
Radial roller bearing with groove in outer race for lock washer

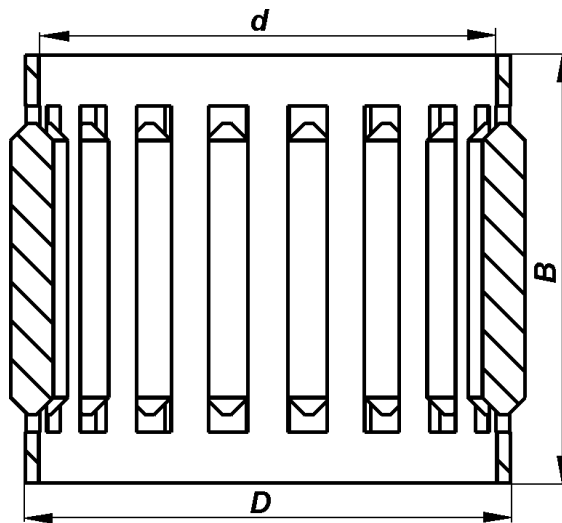

31605-1701086

1701 1 1 25 30 25

Роликовый игольчатый однорядный  
Single-row roller needle bearing

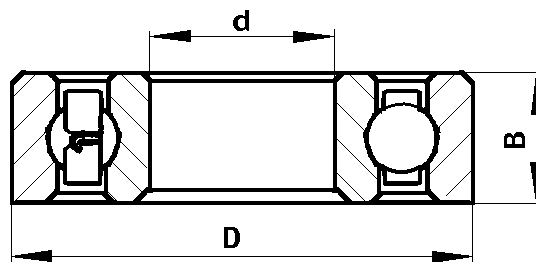

452-1802060

307A

1802 1 1 1 35 80 21

Шариковый радиальный однорядный  
Single-row radial ball bearing

1	2	3	4	5	6	7	8	9	10
---	---	---	---	---	---	---	---	---	----

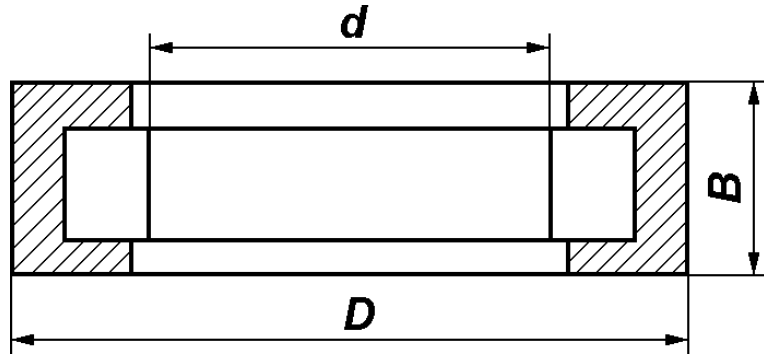

3741-1802092

6-292305-AE

1802

1

1

1

35

62

17

Роликовый радиальный  
однорядный без внутреннего  
кольца  
Single-row radial roller bearing  
without inner race

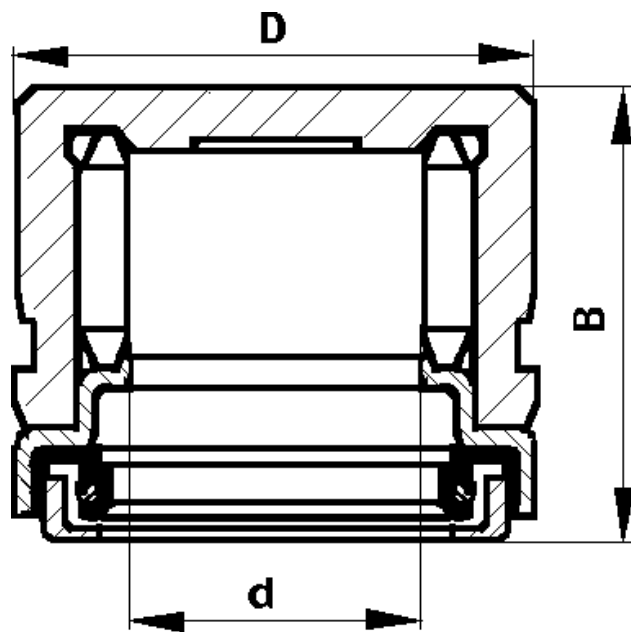

69-2201033-A

704702KY2

2201

8

8

8

16,3

30

25

2203

8

8

8

Роликовый радиальный  
игльчатый без внутреннего  
кольца  
Radial needle roller bearing  
without inner race

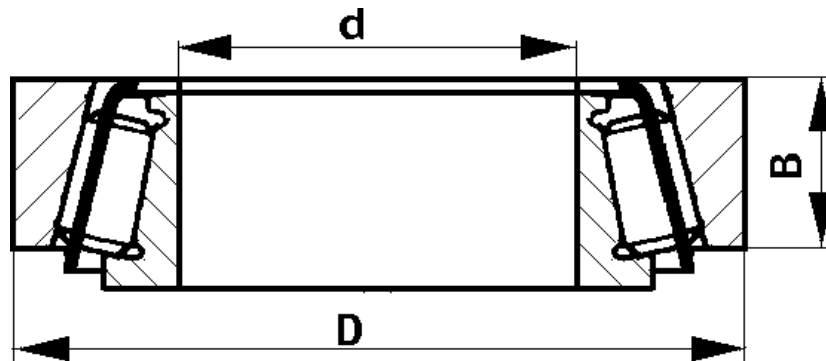

452-2403036

Y-7510A

2303

2

2

2

50

90

25

2403

2

2

2

Роликовый радиально-  
упорный однорядный  
конический  
Single-row roller radial-thrust  
taper bearing

1	2	3	4	5	6	7	8	9	10
---	---	---	---	---	---	---	---	---	----

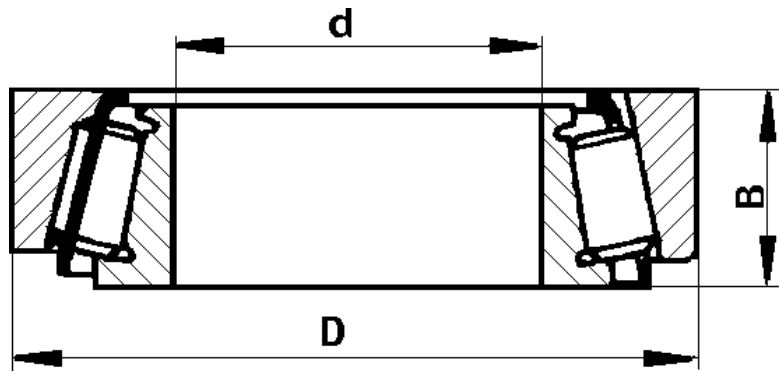

469-2402025-10	6Y-7606 АУШ	2402	2	2	2	30	72	29	Роликовый радиально-упорный однорядный конический
	7606 АУ								
	7606 А	2302	2	2	2	40	90	35,25	Radial-thrust single-row taper roller bearing
	6Y-7608A	2402	2	2	2				

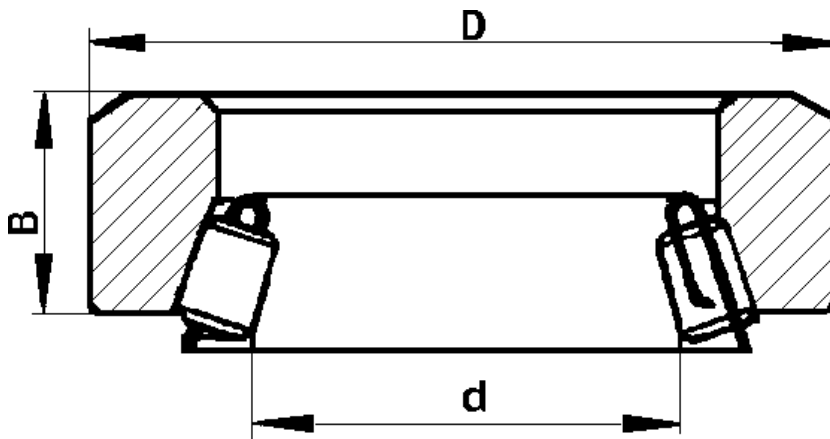

20-3401071	977907K1	3401	-	-	1	33,02	49,225	11	Роликовый радиально-упорный, однорядный конический без внутреннего кольца
20-3401075	877907K	3401	-	-	1	33,02	58	17	

Radial-thrust single-row taper roller bearing without inner race

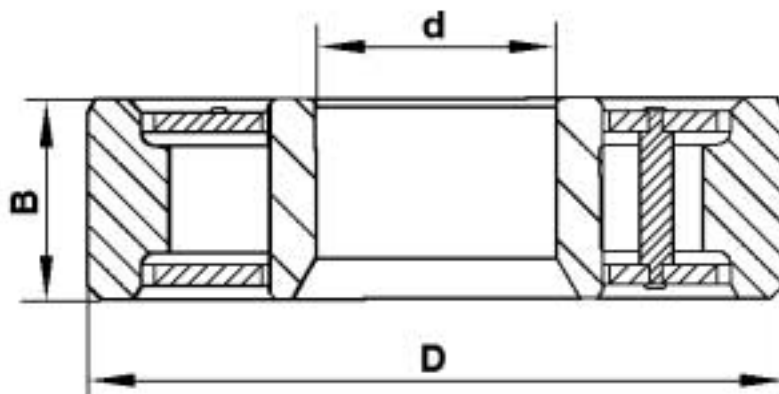

3151-3401078		3401	-	-	1	18	52	15	Роликовый радиальный с короткими роликами с внутренним кольцом
3151-3401078-01+									

Radial roller with short rollers with inner race

1	2	3	4	5	6	7	8	9	10
---	---	---	---	---	---	---	---	---	----

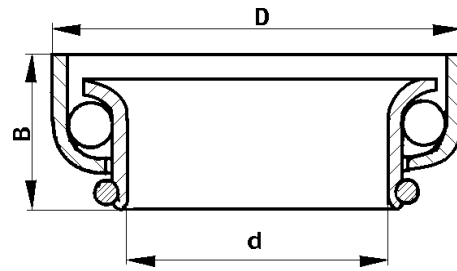

12-3401120

636905

3401 2 2 2 23,5 36,5 14

Шариковый радиально-упорный однорядный без сепаратора со штампованным кольцом  
Single-row radial-thrust ball bearing without cage, with stamped race

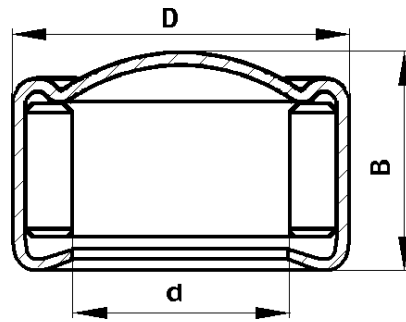

3151-3401160

904900

3401 8 8 8 10 16 10,2

Роликовый игольчатый  
Needle roller bearing

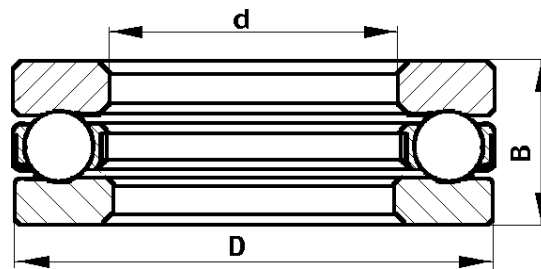

6-8102

3706 1 - - 15 28 9

Шариковый радиально-упорный  
Radial-thrust ball bearing

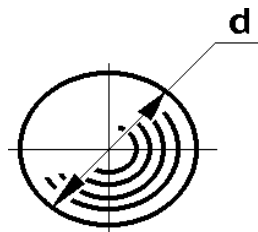

БШ 2,381 НЮ

1107

1

-

-

2,381

-

-

Шарик Ш

БЗ 3,175 60Ю

1107

1

-

-

3,175

-

-

Шарик Ш

263014

1702

3

3

3

9,525

-

-

Шарик IV

263014-П

1803

2

2

2

9,525

-

-

Шарик VI

353087

3507

2

2

2

11,9

-

-

Шарик I

506607

1310

1

1

1

7,938

-

-

Шарик БV

Ball БV

## САЛЬНИКИ И МАНЖЕТЫ GLANDS AND COLLARS

Обозначение сальника Designation	подгруппы, где применяется Subgroup No.	Количество на подгруппу Qty per subgroup			Размеры, мм Dimensions, mm				Наименование Description
		УАЗ-31519	УАЗ-315195	УАЗ-315143	d	D	D <sub>1</sub>	H	
1	2	3	4	5	6	7	8	9	10

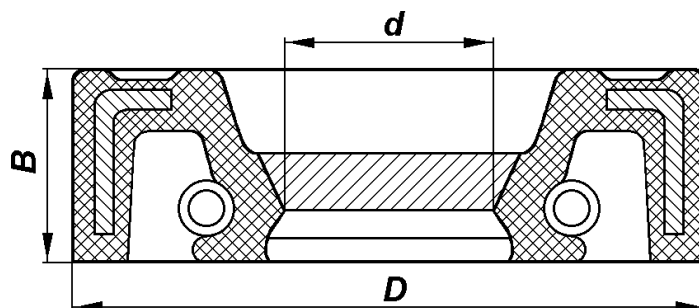

53-1005034

1002    1    -    -    54,4    80    61,5    10

Сальник передний коленчатого вала с пружиной в сборе  
Crankshaft front gland with spring in assy

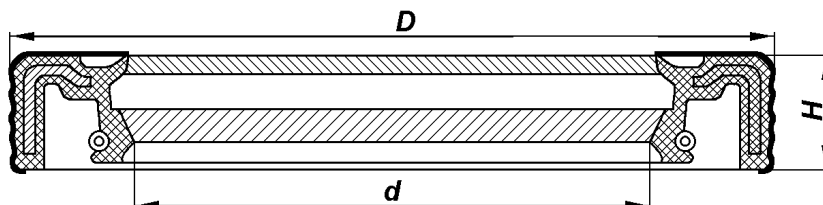

2108-1005160  
2108-1005160-03

1005    -    1    -    80    100    -    10  
1005    1    -    -

Сальник коленчатого вала задний с пружиной в сборе  
Crankshaft rear gland with spring in assy

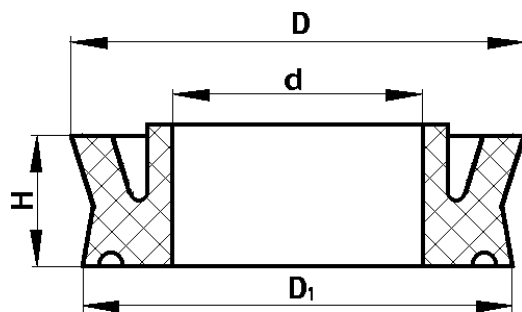

469-1602548  
24-1602516

1602    1    1    1    23,4    21,7    7    -  
1602    1    1    1

Манжета уплотнительная  
Sealing collar

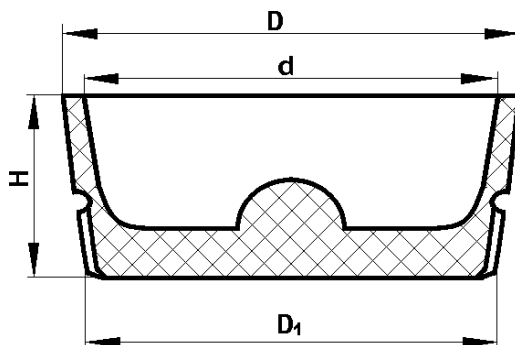

469-1602554

1602    1    1    1    20    23    21    9

Манжета уплотнительная поршня главного цилиндра  
Master cylinder piston sealing collar

1	2	3	4	5	6	7	8	9	10
---	---	---	---	---	---	---	---	---	----

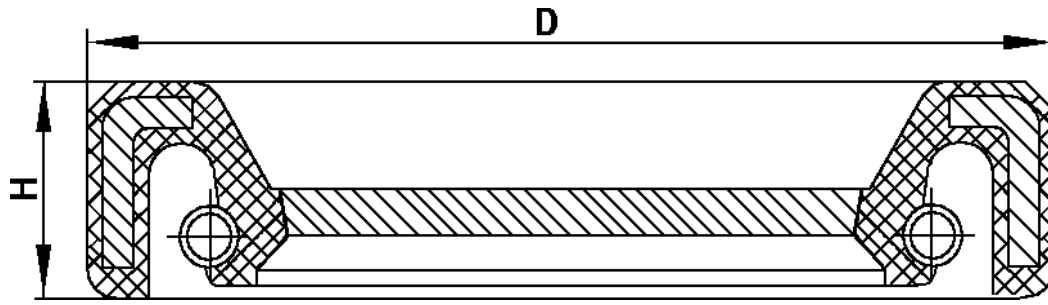

31605-1701045	1701	1	1	1	35	48	-	7	Манжета в сборе Collar in assy
---------------	------	---	---	---	----	----	---	---	-----------------------------------

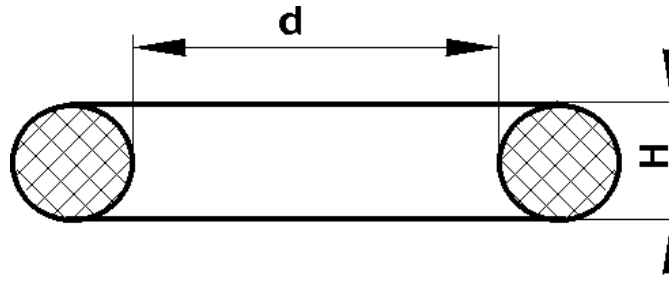

69-3802032	1802	1	1	1	18,25	-	-	2,5	Кольцо уплотнительное Sealing ring
3151-3502051	3502	8/*	8	8	18,5	-	-	3,6	
24-10-3502051	3502	-/8*	-	-	21,5	-	-	3,6	
	3505	2	2	2					
3151-3510124	3510	1	1	1	26,5	-	-	2,5	

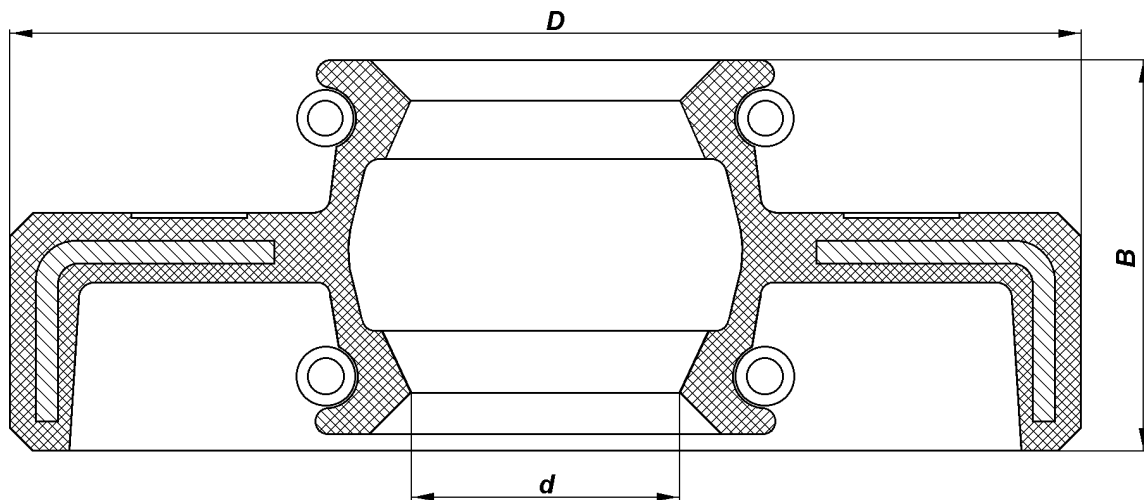

3741-1701210	1802	2	2	2	42	68	-	16,4	Манжета в сборе
3160-2402052	2402	1	1	1	42	75	-	16,4	Collar in assy

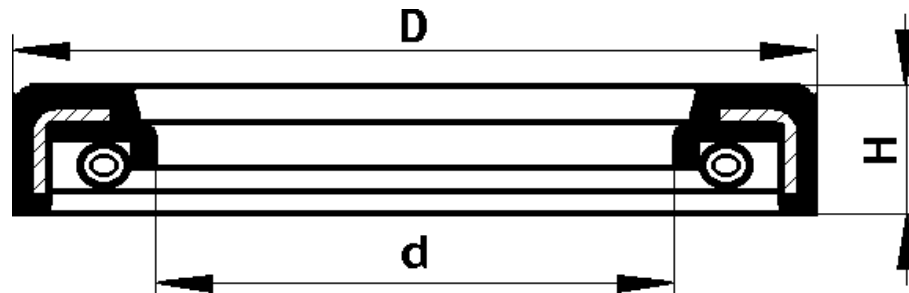

469-2201028	2201	8	8	8	17,5	27,6	-	4,0	Манжета крестовины карданного вала с пружиной в сборе
	2203	8	8	8					Propeller shaft centre cross collar with spring in assy



1	2	3	4	5	6	7	8	9	10
---	---	---	---	---	---	---	---	---	----

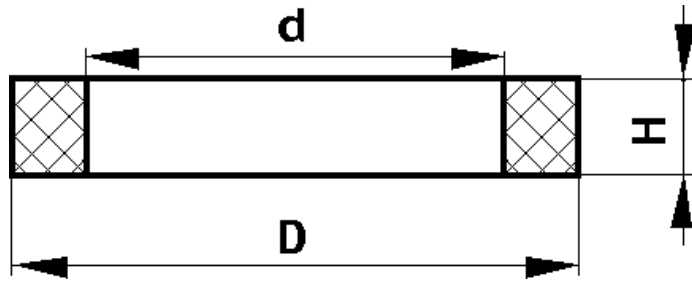

3741-2201085	2201	1	1	1	36,5	50,5	-	6	Кольцо уплотнительное сальника скользящей вилки карданного вала наружное Propeller shaft slip yoke gland outer sealing ring
	2203	1	1	1					
3741-2201088	2201	1	1	1	35,5	51	-	6	Кольцо уплотнительное сальника скользящей вилки карданного вала внутренняя Propeller shaft slip yoke gland inner sealing ring
	2203	1	1	1					

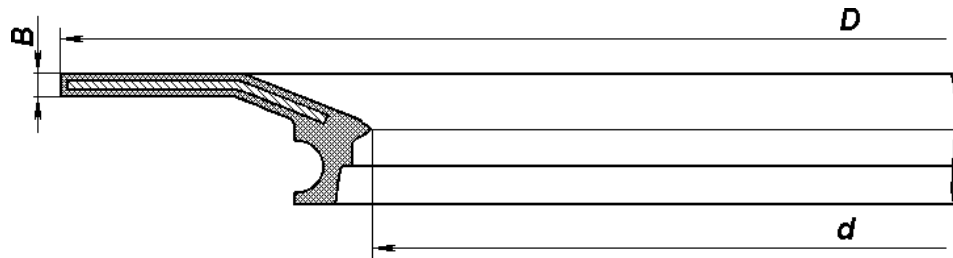

3160-2304052	2304	2	2	2	122	184	-	3,9	Манжета поворотного кулака Steering knuckle collar
--------------	------	---	---	---	-----	-----	---	-----	---

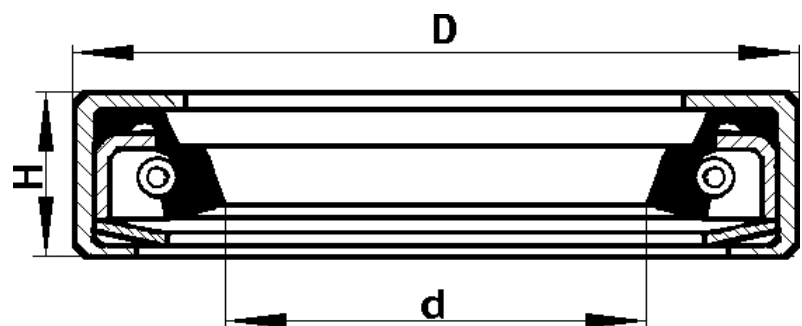

3741-2304071	2304	2	2	2	30	50	-	10	Манжета кулака шарнира в сборе Knuckle gland in assy
--------------	------	---	---	---	----	----	---	----	---

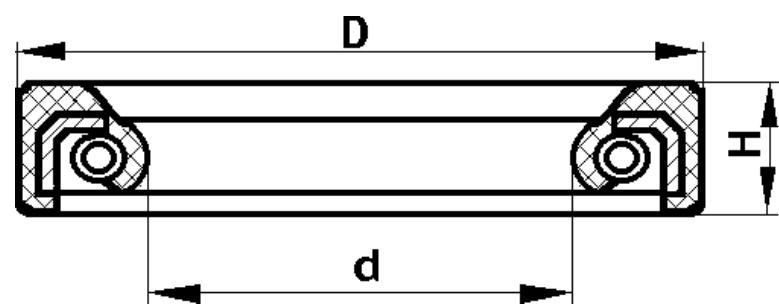

3741-3103038	3103	4	4	4	60	85	-	10	Манжета ступицы колеса с пружиной в сборе Wheel hub gland with spring in assy
20-3401023-Б	3401	-	-	1	38	44	-	10	Сальник вала сошки рулевого управления с арматурой в сборе Steering arm shaft gland with fittings in assy

1	2	3	4	5	6	7	8	9	10
---	---	---	---	---	---	---	---	---	----

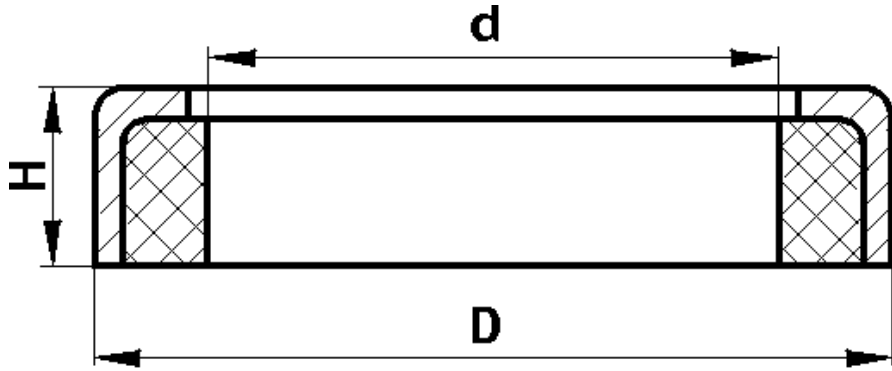

M-3549

3401 - - 1 22 29,85 - 6,5

Сальник горловины картера  
рулевого управления  
Steering mechanism case neck gland

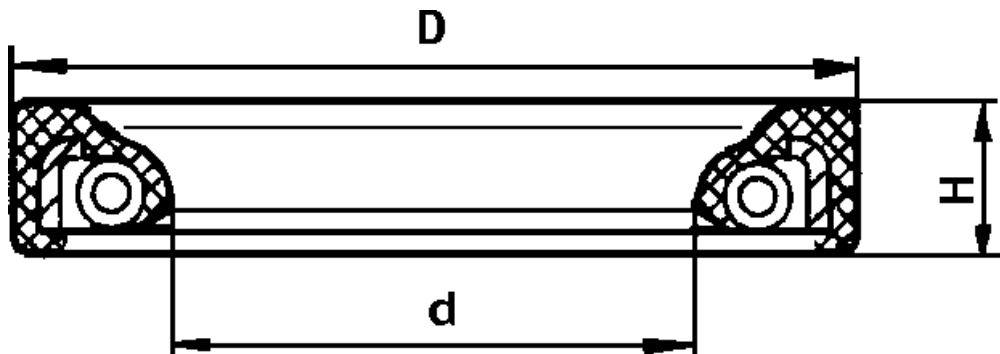

469-3401069

3401 - - 1 22 34,9 - 6

Сальник вала червяка  
Worm shaft gland

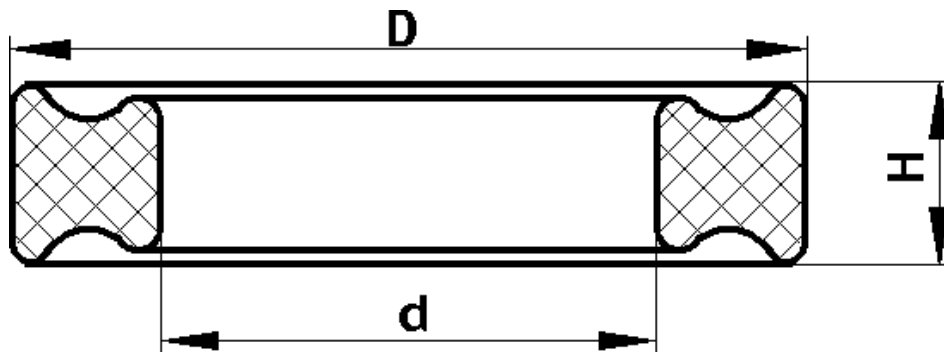

469-3401156

3401 8 8 8 98 15,0 - 3

Сальник подшипника карданного  
шарнира  
Propeller shaft bearing gland

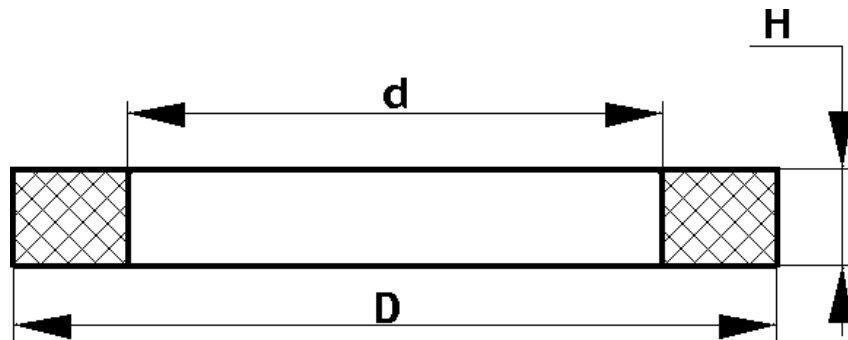

2101-3501051

3501 4 4 4 48,5 54,5 - 3,3

Кольцо уплотнительное поршня  
колесного цилиндра  
Wheel cylinder piston sealing ring



1	2	3	4	5	6	7	8	9	10
---	---	---	---	---	---	---	---	---	----

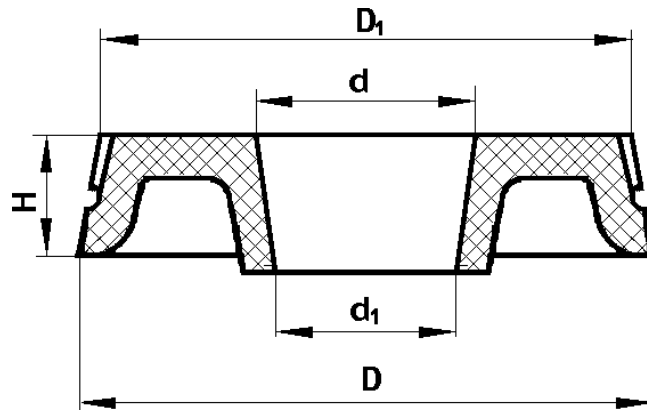

469-3505035

3505

2 2 2 9/10\* 29 27 7

Манжета уплотнительная  
первичного и вторичного  
поршней главного цилиндра  
Master cylinder primary and  
secondary piston sealing collar

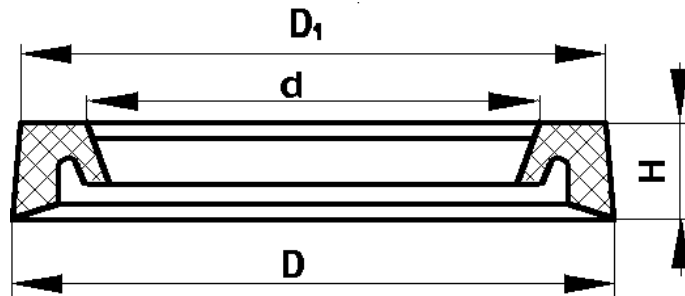

3151-3510034

3510

1 1 1 51,0 65,0 64,0 8

Манжета уплотнительная корпуса  
Housing sealing collar

3151-3510114

3510

1 1 1 37,0 49,2 48 7

Манжета уплотнительная крышки  
первичной камеры  
Primary chamber cover sealing ring

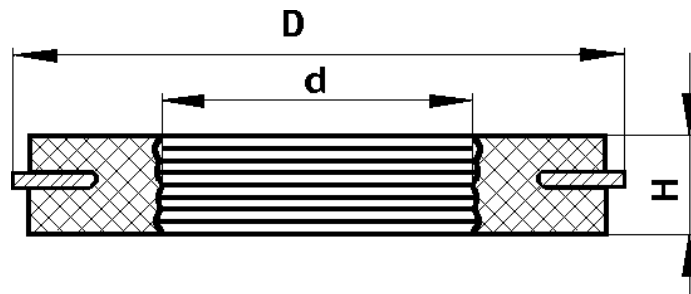

3151-3510060

3510

1 1 1 15,5 31 29 5

Уплотнитель клапана управления  
Control valve seal

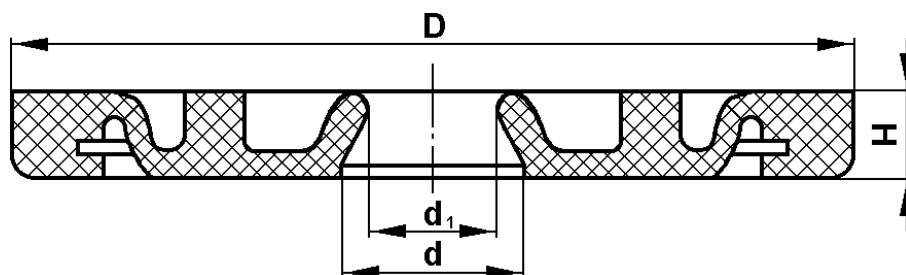

3151-3510174

3510

1 1 1 7,4 10,0 43,8 4,5

Уплотнитель штока поршней  
вакуумного усилителя  
Vacuum booster piston rod seal

## ЭЛЕКТРИЧЕСКИЕ ЛАМПЫ НАКАЛИВАНИЯ FILAMENT LAMPS (BULBS)

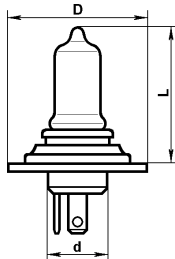
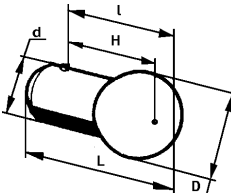
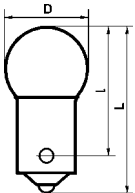
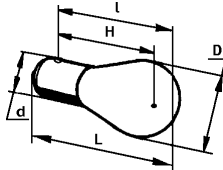
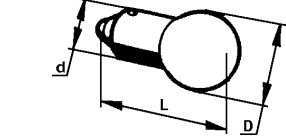
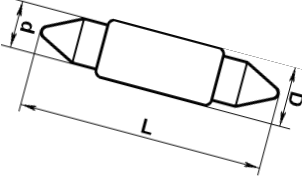
Обозначение лампы по ГОСТ (категория) Designation of lamp to ГОСТ	подгруппы, где применяется Subgroup No.	Количество на подгруппу Qty per subgroup			Мощность, Вт Power, W	Размеры, мм Dimensions, mm				
		УАЗ-31519	УАЗ-315195	УАЗ-315143		D	d	L	l	H
АКГ12-60+55-1	3711	2	2	2	60,0;55,0	45,0	22,0	60,0	-	-
										
A12-5	3712	2	2	2	5	19	15	37,5	30	19
	3716	2	2	2						
	3717	2	2	2						
	3726	2	2	2						
										
A12-5-2	3716	5	5	5	5,0	10,29	-	26,8	20,7	
										
A12-21-3	3712	2	2	2	25	26,5	15-15,25	52,5	45	31,8
	3715	1	1	1						
	3716	6	6	6						
										
A12-10 3741-3713400	3714	1	1	1	19	15	37,5	30	30	19
	3805	5	5	5	2,1	12	9,1-9,25	24	-	-
										
AC12-5-1	3714	1	1	1	5	11	8,5	37	-	-
										

**СТАНДАРТИЗОВАННЫЕ ДЕТАЛИ  
STANDARDIZED PARTS**

**БОЛТЫ  
BOLTS**

Обозначение Designation	подгруппы, где применяется Subgroup No.	Количество на подгруппу Qty per subgroup			Размеры, мм Dimensions, mm				
		УАЗ-31519	УАЗ-315195	УАЗ-315143	d	l	l <sub>0</sub>	H	S
1	2	3	4	5	6	7	8	9	10

**Болты с шестигранной головкой  
Hex-Head Bolts**

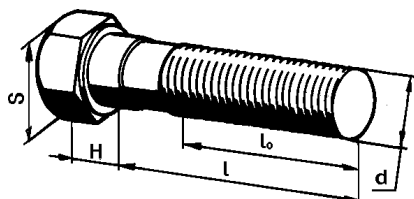

200215	1307	1	-	-	M6	40	26	6	14
200263-П29	1307	-	1	-	M8	35	22	5	12
200271-П29	1007	-	8	-	M8	60	22	5	12
200272-П8	1002	2	-	-	M8	65	22	5	12
200276-П8	3705	-	4	-	M8	85	22	5	12
200279-П29	3701	-	1	-	M8	100	22	5	12
200320-П29	1001	-	2	-	M10	55	26	6	14
	1601	-	2	-					
200326-П29	1601	-	5	-	M10	85	26	6	14
200329-П29	1601	-	2	-	M10	100	26	6	14
200315-П29	1001	-	4	-	M10	40	26	6	14
	6810	6	6	6					
1/60439/21	5325	4	4	4	M8	35	21	5,5	13

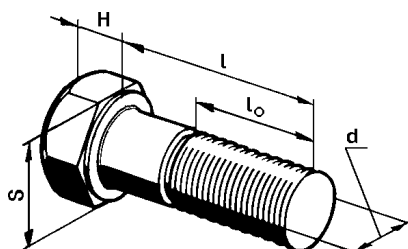

201415-П29	1009	-	6	-	M6	10	10	4	10
	1108	-	-	1					
201416-П29	1105	4	-	4	M6	12	12	4,2	10
	1309	4	4	4					
	1310	4	4	4					
	1702	3	3	3					
	2304	16	16	16					
	1002	5	-	-					
	1601	2	-	-					
	3737	3/4*	-	-					
	5304	7	7	7					
	6306	2	2	2					
201417-П29	1310	2	2	2	M6	14	14	4,5	10
	1311	2	2	2					
	3703	3	3	3					
	8101	3	3	3					
	8406	10	10	10					
201418-П8	1007	6	-	-	M6	16	16	4,5	10
201418-П29	1008	-	2	-	M6	16	16	4,5	10
	1011	-	2	-					
	1104	3	-	-					
	1108	2	2	2					
	1109	1	-	-					
	1117	-	2	-					

1	2	3	4	5	6	7	8	9	10
	2802	5	5	5					
	3403	4	4	4					
	3703	7	7	7					
	3706	1	-	-					
	3847	-	2	-					
	5202	6	6	6					
	5325	2	2	2					
	8406	4	4	4					
	8407	4	4	4					
201419-Π29	2803	2	2	2	M6	18	18	4	10
	3706	1	-	-					
201420-Π29	1014	-	2	-	M6	20	20	4,5	10
	1108	-	-	1					
	3510	6	6	6					
	5113	17	17	17					
	5700	11	11	11					
	6313	2	2	2					
	8403	28	28	28					
201424-Π29	1117	-	1	-	M6	30	20	4,5	10
	3506	-	1	-					
	3512	2	2	2					
201422-Π29	3506	3	2	3	M6	25	20	4,5	10
201426-Π29	1011	4	-	-	M6	35	18	4	10
201452-Π29	1011	-	1	-	M8	12	12	5	12
	1012	4	4	-					
	1310	2	2	2					
	1601	1	-	-					
	3501	4	4	4					
	3502	4	4	4					
	3506	2	2	2					
	8407	8	8	8					
201453-Π29	1101	6	6	6	M8	14	14	5	12
	1164	-	2	-					
	2303	1	1	1					
	2403	1	1	1					
	3410	3	3	-					
	3512	4	2	4					
	5107	4	4	4					
201454-Π8	1003	4	-	-	M8	16	16	5,5	12
	1308	4	4	-					
	1601	8	-	-					
201454-Π29	1006	-	2	-	M8	16	16	5,5	12
	1310	1	1	1					
	1803	1	1	1					
	3721	3	3	3					
	5325	2	2	2					
	6306	2	2	2					
	6820	2	2	2					
	6870	8	8	8					
201455-Π29	1005	-	6	-	M8	18	18	5,5	12
	3105	4/-*	4/-*	4/-*					
	3401	-	-	8					
	3743	4	4	4					
	5205	4	4	4					
201456-Π29	1006	2	-	-	M8	20	20	5	12
	1164	-	1	-					
	1308	-	3	-					
201457-Π29	1308	-	3	-	M8	22	22	5	12
	1702	4	4	4					
	2804	4	4	4					
	3105	-/2*	-/2*	-/2*					
	3508	2	2	2					
	3701	1	-	-					
	6306	2	2	2					
	6870	4	4	4					
201458-Π29	1009	-	11	-	M8	25	22	5	12
	1701	5	5	5					
	1703	1	1	1					
	1802	21	21	21					
	1803	1	1	1					
	3512	1	2	1					
	5201	4	4	4					
	5700	8	8	8					

1	2	3	4	5	6	7	8	9	10
	6001	2	2	2					
	6870	4	4	4					
201460-П8	1306	2	-	-	M8	30	22	5	12
	1601	4	-	-					
201460-П29	1008	-	2	-	M8	30	22	5	12
	1011	2	-	-					
	1306	-	1	-					
	1602	2	2	2					
	1803	4	4	4					
	3701	-	1	-					
201463-П29	1109	-	2	2	M8	38	22	5	12
	1801	4	4	4					
	1802	2	2	2					
	6870	4	4	4					
201468-П2	2912	2	2	2	M8	50	22	5	12
201468-П29	3701	-	1	-	M8	50	22	5	12
201476-П29	6106	16	16	16	M8x1	20	20	5,5	12
201478-П29	1203	5	5	8	M8x1	25	22	5	12
201480-П29	3410	1	1	-	M8x1	30	22	5	12
201482-П29	1203	1	2	1	M8x1	35	22	5	12
	3401	1	1	2					
201490-П29	1203	-	1	-	M8	60	22	5	12
201493-П29	3724	-	-	1	M10	16	20	6	14
201495-П8	3507	4	4	4	M10	20	20	6	14
201495-П29	1001	2	2	2	M10	20	20	6	14
	1105	4	-	4					
	1109	2	-	-					
	1802	4	4	4					
	6820	4	4	4					
201496-П29	2804	8	8	8	M10	22	22	6	14
	6306	6	6	6					
	8217	4*/10*1	4*/10*1	4*/10*1					
201497-П29	2304	12	12	12	M10	25	25	6	14
	2803	4	4	4					
	3407	2	-	-					
	3510	2	2	2					
	5700	2	2	2					
	6001	4	4	4					
	8217	4	4	4					
201498-П29	2912	8	8	8	M10	28	26	6	14
201499-П29	1001	6	-	-	M10	30	26	6	14
	1011	-	2	-					
	1601	-	2	-					
	3512	1	-	1					
201501-П8	1002	4	-	-	M10	35	26	6	14
	1601	4	-	-					
201501-П29	1701	5	5	5	M10	35	26	6	14
	3701	-	2	-					
201503-П29	1001	-	4	-	M10	40	26	6	14
201508-П29	1001	-	2	-	M10	55	26	6	14
	1701	2	2	2					
201510-П8	3105	-/2*	-/2*	-/2*	M10	65	30	7	14
201514-П8	2304	2	2	2	M10x1	16	16	7	14
201518-П29	2201	8	8	8	M10x1	25	25	7	14
	2203	8	8	8					
201521-П8	1601	-	1	-	M10x1	32	30	7	14
201521-П29	1601	1	-	-	M10x1	32	30	7	14
201538-П29	2801	8	8	8	M12	25	25	7	17
201540-П29	3407	2	2	2	M12	30	30	7	17
201542-П29	1001	-	-	6	M12	35	20	7	17
	1002	2	-	-					
	1601	2	-	-					
201544-П29	1801	1	1	1	M12	40	30	7	17
201546-П29	1801	1	1	1	M12	45	26	6	14
201561-П29	1001	4	4	4	M12x1,25	25	25	7	17
	2906	4	4	4					
201563-П	1006	-	2	-	M12x1,25	30	30	7	17
201563-П29	1001	2	2	2	M12x1,25	30	30	7	17
	1006	1	-	-					
201565-П29	2912	2	2	2	M12	35	30	7	17
201569-П29	2902	2	2	2	M12x1,25	45	26	6	14
	2905	4	4	4					
201575-П29	2905	2	2	2	M12x1,25	70	40	7	17

1	2	3	4	5	6	7	8	9	10
	2915 <sup>+</sup>	2	2	2					
202154-П29	2909	2	2	2	M16x1,5	85	40	9	22
201626-П29	1001	1	1	1	M14x1,5	90	50	9	22
290656-П8	1601	6	-	-	M8	30	22	5,5	12
290656-П29	1005	6	-	-	M8	30	22	5,5	12
	1601	-	6	-					
290753-П29	2401	12	12	12	M10	20	13	6	14
290775-П29	3701	2	-	-	M10	40	30	7	14
290813-П29	1101	4	4	4	M10	45	30	7	14
350004-П29	2303	10	10	10	M12x1,25	22	15	7	19
	2403	10	10	10					
360007	2304	12	12	12	M10	28	18	10	14
	2403	20	20	20					
45 9318 1126	3501	4	4	4	M12	40	40	7,5	18
45 9318 0132	1005	-	1	-	M12	70	30	7,5	18
45 9318 1158	3501	4	4	4	M12x1,5	55	-	-	-
45 9377 1687	3501	4	4	4	M10x1,25	70	45	6	14
45 9318 1197	2909	4	4	4	M16	90	38	10	24
	1012	6	6	-	-	30	18	4	10

**Болт с шестигранной головкой и шлицем в головке  
Hex-Head Bolt with Spline in Head**

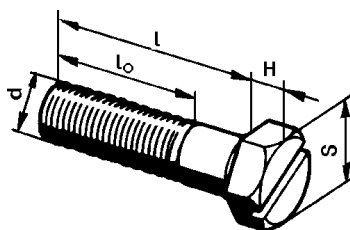

290628-П29	1106	2	-	-	M8	32	9	5,5	12
	1106 <sup>+</sup>	2	-	-					

**Болт с шестигранной головкой и отверстием в головке  
Hex-Head Bolt with Hole in Head**

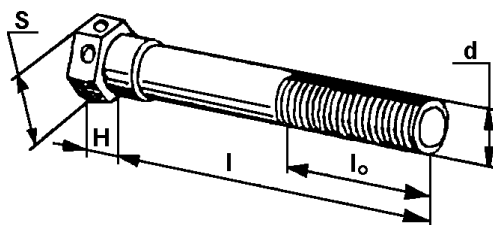

206461-П29	1802	1	1	1	M6	14	14	4	10
206542-П29	1302	2	2	2	M10	40	25	7	14
290784-П29	2304	4	4	4	M10x1	30	30	7	14

**Болты с полукруглой головкой и квадратным подголовком  
Round Head Bolts with Square Neck**

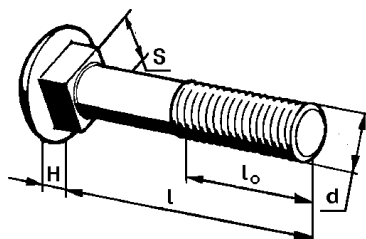

210358-П29	3701	1	-	-	M6	20	18	3	6
290377-П29	1108	2	-	-	M5	9	9	3,5	10



1	2	3	4	5	6	7	8	9	10
---	---	---	---	---	---	---	---	---	----

**Болт специальный  
Special Bolt**

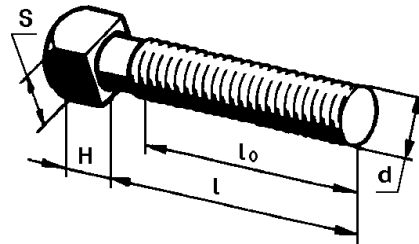

290659-П16	3724	2	2	2	M8x1	30	25	-	5,5	-	12
------------	------	---	---	---	------	----	----	---	-----	---	----

**Болты с шестигранной головкой с нормальным зубчатым буртиком  
Hex-Head Bolts with Standart Serrated Collar**

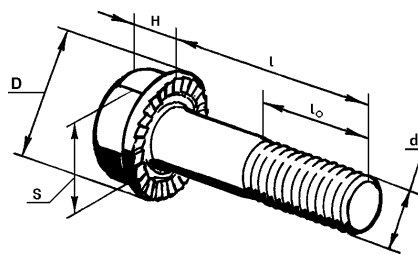

1/38364/21	1204	-	4	-	M6	16	16	5,5	10
1/38381/21	6110	6	6	6	M8	20	20	8	13
	6210	6	6	6					

Обозначение Designation	подгруппы, где применяется Subgroup No.	Количество на подгруппу Qty per subgroup			Размеры, мм Dimensions, mm					
		УАЗ- 31519	УАЗ- 315195	УАЗ- 315143	d	l	l <sub>0</sub>	D	H	S
1	2	3	4	5	6	7	8	9	10	11

**Болт с буртиком  
Bolt with Collar**

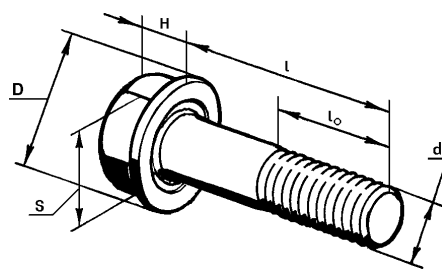

360001	2303	8	8	8	M10	55	29	10	14	12,6
360001	2403	8	8	8						
360007	2304	12	12	12	M10	25	16,5	10	14	12,6
360007	2403	20	20	20						
45 9376 1104	1003	-	4	-	M6	20	-	6,8	8	7,2
45 9376 1106	1005	-	6	-	M6	25	18	6,8	8	7,2
45 9376 1108	1003	-	2	-	M6	30	18	6,8	8	7,2
45 9376 1110	1014	-	2	-	M6	35	18	6,8	8	7,2
45 9376 1117	2301	10	10	10	M8	16	-	8,5	10	9
	2401	10	10	10						
	3507	1	1	1						
45 9376 1119	1310	2	2	2	M8	20	-	16,3	8	12
	1602	1	1	1						
45 9376 1121	1003	-	2	-	M8	25	-	8,5	10	9
45 9377 1125	1006	-	4	-	M8	35	-	8,5	10	9

Обозначение Designation	подгруппы, где применяется Subgroup No.	Количество на подгруппу Qty per subgroup			Размеры, мм Dimensions, mm				
		УАЗ- 31519	УАЗ- 315195	УАЗ- 315143	в корпус in housing			под гайку for nut	
					l	d <sub>1</sub>	l <sub>1</sub>	d	l <sub>0</sub>
1	2	3	4	5	6	7	8	9	10

### ШПИЛЬКИ STUDS

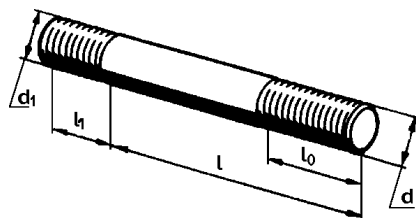

290144-П2	1602	2	2	2	20	M8	14	M8x1	16
290146-П8	1008	1	-	-	32	M8	16	M8x1	18
290155-П2	1801	2	2	2	40	M12x1,25	18	M12	22
291747	1016	2	-	-	22	M8x1,25	16	M8x1	13
291750	1008	2	-	-	25	M8x1,25	16	M8x1	18
291750-П2	1009	-	4	-	25	M8x1,25	16	M8x1	18
291751-П2	1008	-	4	-	30	M8	16	M8	20
	3855	-	1	-					
291781	1007	4	-	-	65	M10x1,25	-	M10x1	-
	1306	1	-	-					
291847-П29	1601	-	4	-	32	M12	24	M12	22
291792-П2	1003	-	3	-	28	M10	20	M10	18
291797	1008	5	-	-	30	M10x1,25	18	M10x1	18
	1306	1	-	-					
291815-П2	1003	-	2	-	80	M10	20	M10	20
353300-П	1008	2	-	-	28	M10x1,25	15	M10x1	22
	1203	2	4	2					

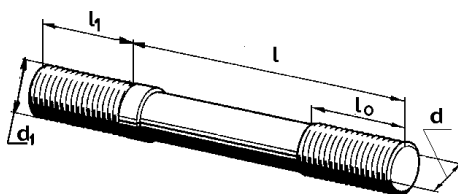

291752-П	1002	1	-	-	38	M8x1	16	M8x1	18
291752-П2	1008	-	1	-	38	M8x1	16	M8x1	18
291762	1307	2	-	-	75	2M8x1	16	M8x1	18

Обозначение Designation	подгруппы, где применяется Subgroup No.	Количество на подгруппу Qty per subgroup			Размеры, мм Dimensions, mm			
		УАЗ-31519	УАЗ-315195	УАЗ-315143	d	l	l <sub>0</sub>	H
1	2	3	4	5	6	7	8	9

### ВИНТЫ SCREWS

#### Винты с полукруглой головкой Round-Head Screws

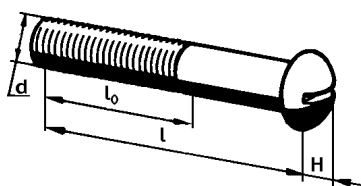

220002-П29	3706	3	-	-	M3	7	7	2,1
------------	------	---	---	---	----	---	---	-----

1	2	3	4	5	6	7	8	9
220003-П29	1107	8	-	-	M3	8	6	2,1
220050-П29	1107	1	-	-	M4	8	8	2,8
	3706	1	-	-				
	6305	2	2	2				
220051-П29	1107	2	-	-	M4	10	10	2,8
	3706	2	-	-				
220052-П29	1107	4	-	-	M4	12	12	2,8
220053-П29	3712	6	6	6	M4	14	14	2,8
	3716	2	2	2				
220056-П29	1107	4	-	-	M4	20	14	2,8
220077-П29	1107	1	-	-	M5	10	10	3,5
220078-П29	3706	2	-	-	M5	12	12	3,5
220079-П29	1107	8	-	-	M5	14	12	3,5
220082-П29	1107	1	-	-	M5	20	18	3,5
220086-П29	1107	1	-	-	M5	30	18	3,5
	1109	1	-	-				
	3402	1	1	1				
220105-П29	3722	4	4	4	M6	16	-	4,2
220110-П29	2807	2	2	2	M6	28	4,2	10
220111-П29	3708	2	-	-	M6	30	24	5,6
220112-П29	1107	2	-	-	M6	30	24	5,6
45 9432 1057	1008	-	4	-	M4	18	2,8	7
45 9432 1079	1007	-	8	-	M5	10	3,5	8,5

**Винты с потайной головкой**  
**Countersunk Screws**

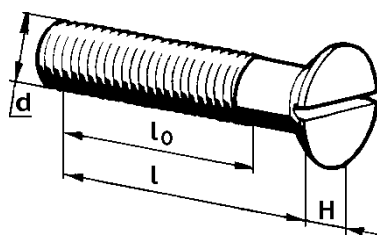

231513-П29	3715	2	2	2	M3	30	12	1,5
221580-П29	1803	2	2	2	M5	16	-	1,2
290605-П29	3103	12	12	12	M8	12	8	4
	3507	2	2	2				
874402-П29	1002	-	3	-	M8	30	13	8
	1008	-	3	-				
874403-П29	1002	-	7	-				
	1008	-	1	-				
874404-П29	1002	-	1	-	M8	30	13	8
	1306	-	2	-				

**Винты с цилиндрической головкой**  
**Round-Head Screws**

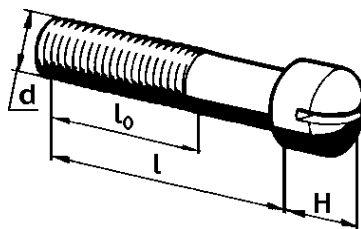

222496-П29	1310	2	2	2	M5	8	-	4,5
222527-П29	2804	6	6	6	M6	20	18	5,5
	2808	2	2	2				
	6106	8	8	8				
222528-П29	1106	2	-	-	M6	22	22	7
222532-П29	8202	6	6	6	M6	30	30	5,5
222537-П29	8202	6	6	6	M6	45	35	5,5
222963-П29	1107	2	-	-	M4	20	18	5,5
874405-П29	1011	-	3	-	M8	28	13	8

1	2	3	4	5	6	7	8	9
---	---	---	---	---	---	---	---	---

**Винты с полупотайной головкой**  
**Semicountersunk Screws**

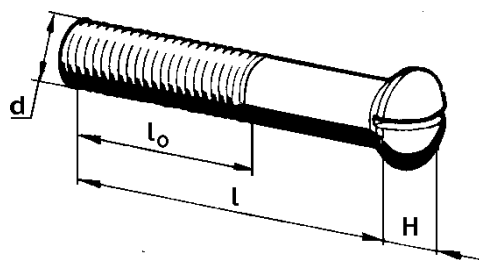

223014-П29	1107	4	-	-	M4	14	8	3,4
223040-П29	8201	2	2	2	M5	16	16	4,3
223043-П29	3805	3	3	3	M5	22	16	4,3
	5301	2	2	2				

**Винты с плоской головкой**  
**Flat Head Screws**

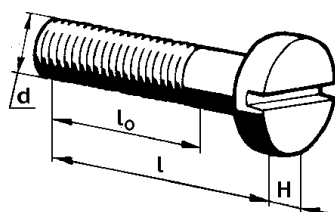

224571-П29	5405	4	4	4	M4	10	10	2
224598-П29	6105	2	2	2	M5	12	2,5	10
	6305	1	1	1				
224599-П29	3716	8	8	8	M5	14	14	2,5
	8412	22	22	22				
224600-П29	3726	2	2	2	M5	16	-	2,5
	3747	3	3	3				
224624-П29	3747	-	-	2	M6	14	3	12
224625-П29	5109	2	2	2	M6	16	3	12

**Винты установочные с плоским концом**  
**Setting Screws with Flat End**

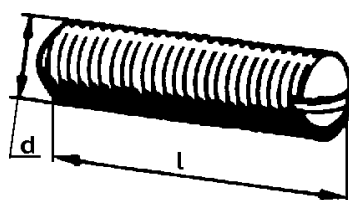

242469-П29	8101	1	1	1	M5	8	-	-
------------	------	---	---	---	----	---	---	---

**Винты с плоской головкой самонарезающие (для металла)**  
**Flat Head Self-Tapping Screws (for Metal)**

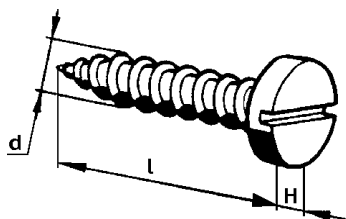

240817-П29	3714	3	3	3	4	10	-	2
240818-П29	3402	2	2	2	4	12	-	2
	5304	4	4	4				
	5604	26	26	26				
240820-П29	3714	2	2	2	4	18	-	2

1	2	3	4	5	6	7	8	9
---	---	---	---	---	---	---	---	---

**Винты с полупотайной головкой самонарезающие (для металла)**  
**Semicountersunk Self-Tapping Screws (for Metal)**

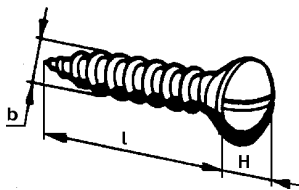

240084-П29	6105	2	2	2	4	12	-	3,5
240620-П29	3401	4	4	4	4	18	-	3,5
241839-П29	3401	1	1	1	5	22	-	3,8
1/76790/01	6870	2	2	2	6	18	-	3

**Винт стопорный**  
**Stop Screw**

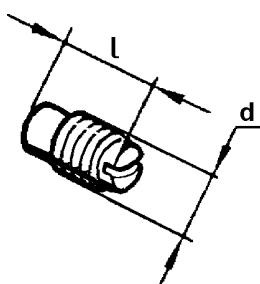

351307	3510	2	2	2	M8	18	-	-
--------	------	---	---	---	----	----	---	---

Обозначение Designation	подгруппы, где применяется Subgroup No.	Количество на подгруппу Qty per subgroup			Размеры, мм Dimensions, mm				
		УАЗ- 31519	УАЗ- 315195	УАЗ- 315143	l	d <sub>1</sub>	l <sub>1</sub>	d	l <sub>0</sub>
1	2	3	4	5	6	7	8	9	10

**Винты с цилиндрической головкой и фрезерованным шлицем**  
**Round-Head Screws with Milled Slot**

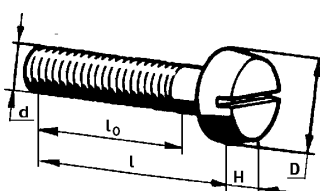

1/03766/01	5604	1	1	1	M6	14	-	4	10
1/03770/01	8201	8	8	8	M6	25	-	4,5	10
1/03895/01	3708	2	-	-	M5	14	-	4	10
1/03898/01	3716	-/2*	-/2*	-/2*	M5	20	16	3,5	9
1/03899/01	3402	2	2	2	M5	25	18	4	10

**Винты с цилиндрической головкой и крестообразным шлицем**  
**Round-Head Screws with Cross Slot**

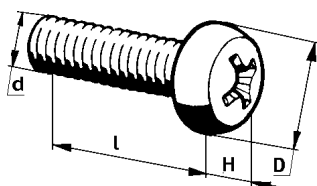

1/32718/01	6003	18	18	18	M4	8	-	3,2	8
1/32719/01	8101	2	2	2	M4	10	-	3,2	8
1/32721/01	3402	5	5	5	M4	14	-	3,2	8

1	2	3	4	5	6	7	8	9	10	
1/32739/01	5301	2	2	2	M5	10	-	4	10	
	6105	8	8	8						
	6305	2	2	2						
1/32740/01	1104	10	5	20	M5	12	-	4	10	
	3711	8	8	8						
	3827	10	5	10						
	8204	4	4	4						
	8401	8	8	8						
	8402	4	4	4						
1/32742/01	3708	1	1	-	M5	16	-	4	10	
	3733	1	-	-						
	8102	4	4	4						
1/32760/01	1116	1	-	-	M6	12	-	4,5	12	
	3705	2	-	-						
	3716	2/-*	2/-*	2/-*						
	5304	4	4	4						
	6105	16	16	16						
	6305	2	2	2						
	6870	4	4	4						
	8101	2	2	2						
1/32762/01		M6	16	-	4,5	12				
	3708	2	-	-						
	3715	2	2	-						
	3726	2	2	2						
	3733	1	-	-						
	3734	2	-	-						
	3747	-	2	-						
	3763	-	3	-						
	5201	8	8	8						
	6000	11	11	11						
	6305	2	2	2						
	1/32764/01	3722	6	6	6	M6	20	-	4,5	14
		6870	8	8	8					
1/32766/01	3747	-	-	2	M6	25	20	4,5	12	
1/32768/01	8202	6	6	6	M6	30	20	4,5	12	
1/32771/01	8202	6	6	6	M6	45	20	4,5	12	

**Винты с потайной головкой и крестообразным шлицем**  
**Countersunk Screws with Cross Slot**

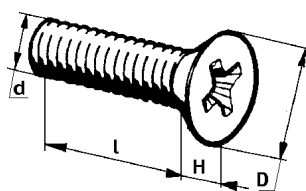

1/33013/01	6105	24	24	24	M6	16	-	3,3	12
	6305	5	5	5					
1/33015/01	5202	6	6	6	M6	20	-	3,3	12
1/32992/01	6105	4	4	4	M5	12	-	2,8	10
	6305	1	1	1					

**Винты с полупотайной головкой и крестообразным шлицем**  
**Semicountersunk Screws with Cross Slot**

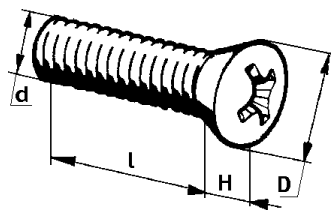

1/33130/01	6306	3	3	3	M6	16	-	3,3	12
------------	------	---	---	---	----	----	---	-----	----

1	2	3	4	5	6	7	8	9	10
617211	1014	6	-	-	M5	14	-	3,3	10

**Винты самонарезающие с цилиндрической головкой и крестообразным шлицем**  
**Round-Head Self-Tapping Screws with Cross Slot**

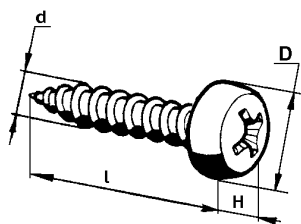

1/76701/01	3402	2	2	2	4,3	12,7	-	2,9	8,2
1/76702/01	5113	6	6	6	4,3	15,9	-	2,9	8,2
1/76712/01	1164	-	2	-	4,9	15,9	-	3,4	9,5
	1213	-	-	2					
	3715	-	-	2					
	5113	4	2	4					

**Винты самонарезающие с полупотайной головкой и крестообразным шлицем**  
**Semicountersunk Self-Tapping Screws with Cross Slot**

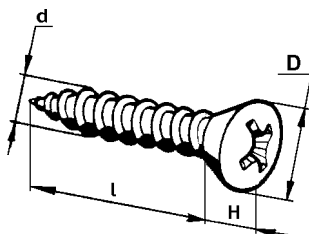

1/76792/07	5109	20	20	20	6	25,4	-	2,1	7,1
------------	------	----	----	----	---	------	---	-----	-----

**ГАЙКИ**  
**NUTS**

Обозначение Designation	подгруппы, где применяется Subgroup No.	Количество на подгруппу Qty per subgroup			Размеры, мм Dimensions, mm		
		УАЗ-31519	УАЗ-315195	УАЗ-315143	d	S	H
1	2	3	4	5	6	7	8

**Гайки шестигранные**  
**Hex Nuts**

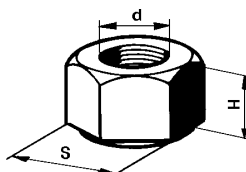

100937	1002	2	-	-	M8	14	7
250458-П29	1107	1	-	-	M3	5,5	2,4
250462-П8	1310	10	10	10	M4	7	3,2
250462-П29	3402	2	2	2	M4	7	3,2
	3706	2	-	-			
	5405	4	4	4			
	8101	2	2	2			
250464-П29	1106	1	-	-	M5	9	4

1	2	3	4	5	6	7	8
	1139	-	8	-			
	3708	4	-	-			
	3712	4	4	4			
	3726	4	4	4			
	8101	2	2	2			
	8208	2	2	2			
	8212	2	2	2			
	8401	4	4	4			
	8402	4	4	4			
	3716	-/2*	-/2*	-/2*			
250503-Π29	1107	4	-	-	M8x1	13	6,5
250508-Π29	1012	6	6	-	M6	11	5
	1104	3	-	-			
	1109	3	-	-			
	1204	-	3	-			
	1310	4	4	4			
	1311	2	4	4			
	2803	4	4	4			
	2804	6	6	6			
	3506	2	3	2			
	3512	2	2	2			
	3708	2	-	-			
	3716	4	4	4			
	3717	4	4	4			
	3724	-	1	-			
	5304	1	1	1			
	8101	2	2	2			
	8403	24	24	24			
	8406	1	1	1			
250510-Π2	2912	2	2	2	M8	14	6
250510-Π16	3724	2	1	2	M8	14	6
250510-Π29	1602	2	2	2	M8	14	6
	1802	2	2	2			
	2804	4	4	4			
	3401	1	1	-			
	3407	5	4	-			
	3410	5	4	-			
	3512	3	2	3			
	3554	-	-	1			
	3701	-	2	-			
	3708	4	-	-			
	3721	1	1	1			
	6001	2	2	2			
	6870	6	6	6			
	8407	4	4	4			
250511	1007	2	-	-	M8x1	14	6
250511-Π8	1009	18	-	-	M8x1	14	6
	1016	2	-	-			
	1307	5	-	-			
250511-Π	1011	4	-	-	M8x1	14	6
250511-Π29	1002	7	-	-	M8x1	14	6
	1008	4	-	-			
	1009	-	4	-			
	1014	2	-	-			
	1203	14	14	15			
	1308	4	-	-			
	1602	2	2	2			
	3401	1	1	2			
	3855	-	1	-			
250512-Π29	1001	2	2	2	M10	17	8
	1601	-	3	-			
	2803	4	4	4			
	2804	8	8	8			
	2912	8	8	8			
	3105	-/2*	-/2*	-/2*			
	3504	2	2	2			
	3505	2	2	2			
	3510	4	4	4			
	3512	3	1	3			
250514-Π29	2801	8	8	8	M12	19	10
	3508	1	1	1			
250515-Π8	1601	6	-	-	M12x1,25	19	10
	3701	2	-	-			



1	2	3	4	5	6	7	8				
250515-П29	1001	4	4	4	M12x1,25	19	10				
	1801	2	2	2							
	2905	8	8	8							
	2906	4	4	4							
	2912	2	2	2							
	2915	4	4	4							
	2915+	4	4	4							
	3502	4	4	4							
250533-П	1008	1	-	-	M6	11	5				
250536-П	1203	4	8	4	M10	17	8				
250559-П29	2912	4	4	4	M14x1,5	22	11				
250561-П29	2909	2	2	2	M16x1,5	24	13				
250608-П29	1108	-	-	1	M6	11	4				
	1309	4	4	4							
	3407	1	1	-							
	3701	1	-	-							
	3708	1	-	-							
	3733	1	-	-							
	3747	-	-	2							
	3763	-	2	-							
	5109	1	1	1							
	5304	1	1	1							
	8101	-	2	2							
	250610-П29	1164	-	3				-	M8	14	5
		1302	4	4				4			
		1602	1	1				1			
1702		1	1	1							
3105		-/2*	-/2*	-/2*							
3507		1	1	1							
250611-П29	1602	1	1	1	M8x1	14	5				
	3508	1	1	1							
250612-П29	1105	2	-	2	M10x1	17	6				
	1109	-	2	2							
	3701	4	-	-							
250613-П29	2304	2	2	2	M10x1	17	6				
250615-П29	1108	2	-	-	M12x1,25	19	7				
250634-П29	1310	1	1	1	M14x1,5	22	8				
250636-П29	2915	2	2	2	M16x1,5	24	8				
	1602	1	1	1							
	3401	1	1	1							
	3506	4	4	4							
250638-П29	2912	2	2	2	M18x1,5	27	9				
	3414	4	4	4							
	3401	-	1	1							
250640-П29	3401	-	1	1	M20x1,5	27	10				
250688-П	1007	4	-	-	M10x1	17	12				
250690-П29	2912	8	8	8	M14x1,5	22	17				
292758-П	1004	8	-	-	M10x1	15	10				
292782-П	1008	7	-	-	M10x1	14	8				
354375-П29	3504	2	2	2	M12x1,5	18	5				
	3720	2	2	2							
	5001	24	24	24							
1/21647/11	5001	24	24	24	M10	17	8				
1/07910/11	1109	-	2	2	M10	17	6				
1/07940/11	3402	2	2	2	M4	7	3,2				
-	1012	6	6	-	6	10	5,2				

**Гайки шестигранные прорезные**  
**Hex Slotted Nuts**

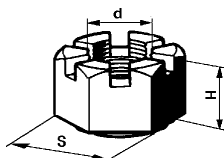

250870-П29	2912	2	2	2	M14x1,5	11	22
250908	2909	2	2	2	M20x1,5	30	22
250977-П29	3105	-/1*	-/1*	-/1*	M12x1,25	19	10
	5606	1	1	1			
250978-П29	3414	4	4	4	M14x1,25	22	11
352220	2909	2	2	2	M20x1,5	27	22

1	2	3	4	5	6	7	8
---	---	---	---	---	---	---	---

**Гайка квадратная  
Square Nut**

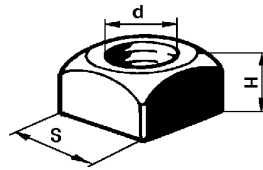

251082-П29	1008 6003	- 18	4 18	- 18	M4	8	3,5
------------	--------------	---------	---------	---------	----	---	-----

**Гайки специальные  
Special Nuts**

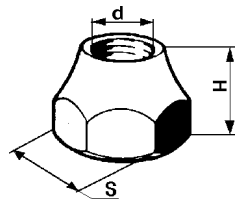

292779-П8	1306	4	-	-	M10x1	19	16
292779-П29	1008	-	5	-	M10x1	19	16

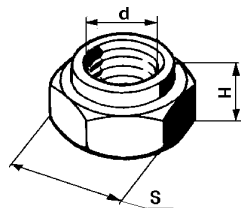

352213	3510	1	1	1	M27x1,5	30	18
352217-П29	3401	1	1	1	M22x1,5	27	15
45 9563 1255	2304	4	4	4	M12x1,25	19	10,3
45 9553 1825	2304	4	4	4	M16x1,5	34	14

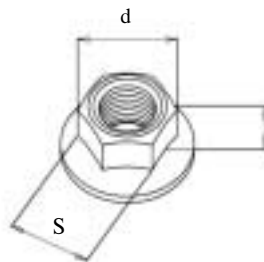

45 9555 6819	1011	-	1	-	M8	16,3	8
874505-П29	1008	-	5	-	M8	17,9	13

**Гайки фланцевые  
Nut with Flange**

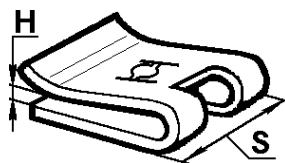

1/41897/76	1164	-	2	-	-	12	1-1,8
	1213	-	-	2			
	3715	-	-	2			
	5113	4	2	4			

1	2	3	4	5	6	7	8
---	---	---	---	---	---	---	---

**Гайки-барашки**  
**Fly Nuts**

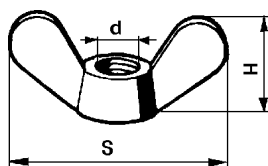

251514-П29	6820	2	2	2	M10	48	22
------------	------	---	---	---	-----	----	----

**ШАЙБЫ**  
**WASHERS**

Обозначение Designation	подгруппы, где применяется Subgroup No.	Количество на подгруппу Qty per subgroup			Размеры, мм Dimensions, mm		
		УАЗ-31519	УАЗ-315195	УАЗ-315143	d	S	D
1	2	3	4	5	6	7	8

**Шайбы плоские**  
**Flat Washers**

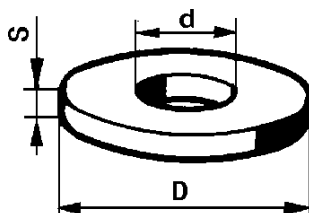

100121	1002	2	-	-	8	1,5	20
	1601	4	-	-			
100935-11	3701	1	-	-	6	1,4	18
100935	3706	1	-	-	6	1,4	18
252000-П29	3708	4	-	-	3,2	0,8	8
	8401	1	1	1			
252002-П29	1305	1	-	-	4,2	1	10
	3706	2	-	-			
	5604	4	4	4			
252003-П29	8401	8	8	8	5,5	1,2	12
252004-П29	1011	-	2	-	6,5	1,4	14
	1014	-	2	-			
	1109	3	-	-			
	1117	-	3	-			
	2802	5	5	5			
	2807	2	2	2			
	2808	2	2	2			
	3706	1	-	-			
	3722	8	8	8			
	3763	-	2	-			
	3847	-	2	-			
	5202	6	6	6			
	5304	4	4	4			
	5700	11	11	11			
	6105	16	16	16			
	6106	8	8	8			
	6305	2	2	2			
	8406	10	10	10			
252005-П29	1008	-	6	-	8,5	1,4	18
	1009	-	15	-			
	1109	-	2	2			
	1164	-	1	-			
	1306	-	2	-			
	1308	-	3	-			
	1802	2	2	2			
	3403	3	3	2			
	3554	-	-	1			

1	2	3	4	5	6	7	8
	3701	-	2	-			
	3708	2	-	-			
	5201	4	4	4			
	5325	2	2	2			
	5605	8	8	8			
	5700	8	8	8			
	6001	2	2	2			
	6870	8	8	8			
	8403	2	2	2			
	8407	8	8	8			
	5702	10	10	10			
	8217	2	2	2			
252006-П29	1001	2	2	2	10,5	2	21
	1109	-	2	2			
	1701	2	2	2			
	3105	-/2*	-/2*	-/2*			
	3724	-	-	1			
	6810	6	6	6			
	6820	4	4	4			
252007-П29	8217	4*/10*1	4*/10*1	4*/10*1			
	3105	-/1*	-/1*	-/1*	12,5	2	25
	3701	1	-	-			
252016-П29	3508	1	1	1	14	2	28
252016-П	3706	1	-	-	14	2	28
252018-П29	2912	2	2	2	19	3	34
252035-П29	3402	2	2	2	4,3	1,2	12
252036-П29	6105	4	4	4	5	1,2	12
	6305	1	1	1			
	8412	22	22	22			
252037-П29	2804	12	12	12	6,5	1,4	18
	3717	4	4	4			
	5109	2	2	2			
	5113	17	17	17			
	5304	2	2	2			
	5325	2	2	2			
	6313	2	2	2			
	8101	2	2	2			
	8403	24	24	24			
252038-П29	1308	-	1	-	8,5	2	22
	3706	1	-	-			
	5205	4	4	4			
	6870	2	2	2			
252039-П29	2803	4	4	4	10,5	3	28
	2804	12	12	12			
	5001	12	12	12			
	5700	2	2	2			
	6001	4	4	4			
252045-П29	2902	2	2	2	12	3	30
	2912	2	2	2			
293171-П2	1011	-	1	-	5,5	1,2	12
293185-П29	3706	2	-	-	5,5	1	10
293196-П	1104	10	5	20	5,5	1	10
	3827	10	5	10			
293221-П29	8101	-	2	2	6	1	9
293224-П	5304	2	2	2	6,5	0,5	24
293225-П29	2803	6	6	6	6,5	1,5	24
	3706	1	-	-			
	5304	2	2	2			
293226-П29	3722	1	1	1	6,5	0,8	17
	3724	1	1	-			
	5304	3	3	3			
293238-П29	5304	1	1	1	7	3	18
293277-П8	1008	-	8	-	8,5	3	19,5
293280-П29	3105	4/-*	4/-*	4/-*	9	1,5	15
293324-П	1007	4	-	-	11,4	1,5	19
293371-П	3706	*	-	-	13	0,5	20
293372-П29	3706	*	-	-	13	1	20
297830-П29	6000	9	9	9	16,5	0,8	25
352503-П29	1204	-	3	-	6,5	1	20
	3407	1	1	-			
	6105	8	8	8			
	8401	4	4	4			
352504-П29	1109	2	-	-	10,5	3	34

1	2	3	4	5	6	7	8				
352512	3510	1	1	1	11	3	34				
352514-П29	3726	2	2	2	6						
	3747	3	3	3							
	8208	2	2	2							
	8401	8	8	8							
	8402	4	4	4							
352515-П29	1101	6	6	6	8	2	22				
	1164	-	2	-							
	1302	4	4	4							
	2804	8	8	8							
	3410	3	3	-							
	3507	1	1	1							
	3508	2	2	2							
	6820	2	2	2							
	6870	4	4	4							
	352517-П29	1001	4	4				4	12,5	2	24
		2801	8	8				8			
		3401	3	3				3			
5606		1	1	1							
6870		2	2	2							
1310		1	1	1							
355600-П29	5304	5	5	5	10,7	1,2	17				
	2912	2	2	2							
356251-П4	3105	-/1*	-/1*	-/1*	14,5	5	54				
	2912	2	2	2							
356252-П4 1/26397/01	1164	-	2	-	25 6	5 1	54 11				
	1213	-	-	2							
	5113	4	2	4							

**Шайбы пружинные  
Spring Washers**

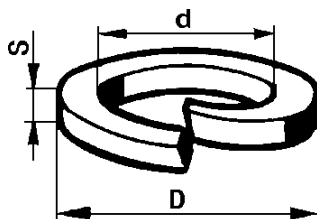

252130-П2	3706	3	-	-	3	1	5,1
252132-П2	3402	2	2	2	4	1,2	6,5
	3706	5	-	-			
	3724	-	1	-			
	5405	4	4	4			
	1106	1	-	-			
252133	1139	-	8	-	5	1,6	8,6
	3708	2	-	-			
252133-П2	3716	8/10*	8/10*	8/10*	5	1,6	8,6
	8208	2	2	2			
252134-П2	1104	3	-	-	6,5	2	10,1
	1105	4	-	4			
	1106	8	-	-			
	1108	2	2	2			
	1109	1	-	-			
	2304	16	16	16			
	2802	5	5	5			
	3506	3	3	3			
	1204	-	3	-			
	3703	10	10	10			
	3708	7	-	-			
	3716	2/-*	2/-*	2/-*			
	3737	3/4*	-	-			
	3763	-	3	-			
	5201	8	8	8			
	5202	6	6	6			
	8403	24	24	24			
	8406	9	9	9			
	8407	4	4	4			
252135-П2	1005	6	-	-	8,5	2,5	23,5
	1006	2	-	-			

1	2	3	4	5	6	7	8
	1011	7	-	-			
	1107	4	-	-			
	1307	-	1	-			
	1601	6	6	-			
	1602	5	5	5			
	1701	5	5	5			
	1702	4	4	4			
	1703	1	1	1			
	1801	4	4	4			
	1802	23	23	23			
	1803	6	6	6			
	3105	-/2*	-/2*	-/2*			
	3403	2	2	2			
	3502	4	4	4			
	3506	2	2	2			
	3508	2	2	2			
	3701	1	-	-			
	3721	3	3	3			
	5107	4	4	4			
	5201	4	4	4			
	5205	4	4	4			
	6106	16	16	16			
252136-Π2	8407	4	4	4			
	1001	6	-	-	10	3,5	17,5
	1002	4	-	-			
	1105	4	-	4			
	1601	8	3	-			
	1701	7	7	7			
	2201	4	4	4			
	2304	18	18	18			
	2401	12	12	12			
	3105	-/2*	-/2*	-/2*			
	3507	4	4	4			
252136-Π29	6306	6	6	6			
	1001	-	6	-	10	3,5	17,5
252137-Π2	1001	-	-	6	12	4	20,5
	1006	1	-	-			
	2303	10	10	10			
	2403	10	10	10			
	2801	8	8	8			
	3401	3	3	3			
	3502	4	4	4			
252138-Π	2912	8	8	8	1,5	4,5	24
252139	2909	4	4	4	10	5	26,3
252140-Π2	2912	2	2	2	18,3	5	29,3
252153-Π2	3706	2	-	-	5,4	1,2	8,6
	3708	5	1	-			
	3747	3	3	3			
252153-Π29	3726	2	2	2	5,4	1,2	8,6
252154	1307	1	-	-	6,5	1,2	8,6
252154-Π2	1002	5	-	-	6,5	1,2	10,5
	1008	-	1	-			
	1011	-	2	-			
	1012	6	6	-			
	1014	-	2	-			
	1109	3	-	-			
	1117	-	3	-			
	1308	-	1	-			
	1309	4	4	4			
	1310	6	6	6			
	1311	4	4	4			
	1601	6	-	-			
	1702	3	3	3			
	1802	1	1	1			
	2803	4	4	4			
	2804	6	6	6			
	3403	4	4	4			
	3512	2	2	2			
	3701	1	-	-			
	3706	2	-	-			
	3708	1	-	-			
	3716	4	4	4			
	3717	4	4	4			

1	2	3	4	5	6	7	8
	3722	8	8	8			
	3747	-	-	4			
	3847	-	2	-			
	5304	8	8	8			
	5325	2	2	2			
	6105	16	16	16			
	6305	2	2	2			
	6870	4	4	4			
252154-Π29	8201	8	8	8	6,5	1,2	10,5
252155-Π2	1002	5	-	-	8	1,5	13,5
	1006	-	2	-			
	1007	2	-	-			
	1011	-	3	-			
	1012	4	4	-			
	1016	2	-	-			
	1106	2	-	-			
	1106 <sup>+</sup>	2	-	-			
	1109	-	2	2			
	1164	-	3	-			
	1203	14	10	15			
	1307	5	-	-			
	1308	8	14	-			
	1310	4	4	4			
	1702	1	1	1			
	2303	1	1	1			
	2403	1	1	1			
	2804	4	4	4			
	3105	4/-*	4/-*	4/-*			
	3401	2	2	10			
	3410	4	4	-			
	3507	1	1	1			
	3512	5	3	5			
	3554	-	-	1			
	3705	-	4	-			
	3708	4	-	-			
	5325	2	2	2			
	5700	8	8	8			
	6001	10	10	10			
	6820	2	2	2			
	6870	8	4	4			
	8217	2	2	2			
252155-Π29	3701	-	3	-	8	1,5	13,5
	3855	-	1	-			
252156-Π2	1001	2	2	2	10,5	2	17,5
	1109	2	-	-			
	1306	4	-	-			
	1601	1	1	-			
	1802	4	4	4			
	2201	4	4	4			
	2203	8	8	8			
	2803	4	4	4			
	2804	8	8	8			
	2912	8	8	8			
	3407	2	-	-			
	3504	2	2	2			
	3505	2	2	2			
	3510	6	6	6			
	3512	1	1	1			
	3724	-	-	1			
	5700	2	2	2			
	6001	4	4	4			
	6810	6	6	6			
	6820	4	4	4			
252156-Π29	8217	4*/14*1	4*/14*1	4*/14*1	10,5	2	17,5
	3701	-	2	-			
	3708	-	2	-			
252157-Π2	1001	6	6	6	12,5	2,5	20,5
	1002	2	-	-			
	1601	2	-	-			
	1801	4	4	4			
	2902	8	8	8			
	2905	8	8	8			

1	2	3	4	5	6	7	8
	2906	8	8	8			
	2912	2	2	2			
	2915	4	4	4			
	2915 <sup>+</sup>	4	4	4			
	3407	2	2	-			
	3508	1	1	1			
	3701	2	-	-			
252158-П2	1001	1	1	1	14,2	3	22,2
	2912	4	4	4			
	2915	2	2	2			
252159-П2	1001	2	2	2	16,3	3	25
	2909	1	1	1			
252162-П2	3401	1	1	1	23	4	36
45 9816 6006	1005	-	6	-	8	1,6	13,1
45 9816 6025	3510	6	6	6	6	2	10
45 9816 6028	1006	-	2	-	12	3	18,1
1/11953/70	3402	2	2	2	4,3	0,9	6,9
-	1012	6	6	-			

**Шайбы пружинные зубчатые с внутренними зубцами**  
**Spring Washers with Inner Teeth**

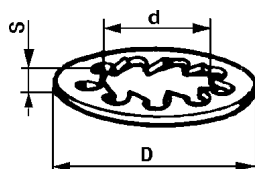

1/26051/70	3402	3	3	3	4,2	1,1	9
1/26053/70	1116	1	-	-	6,2	1,3	12,5
1/26058/71	1310	1	1	1	19,3	2,3	24,1
252172-П29	6305	2	2	2	4,2	1,1	9
	8101	2	2	2			
252173-П29	6105	8	8	8	5,2	1,2	10,5
	6305	2	2	2			
	8101	2	2	2			
	8204	4	4	4			
	8401	4	4	4			
252174-П29	3705	2	-	-	6,2	1,3	12,5
	3715	2	2	2			
	3724	-	-	1			
	3726	2	2	2			
	3733	3	-	-			
	3734	2	-	-			
	3747	-	2	-			
	3763	-	3	-			
	8202	12	12	12			
252175-П29	1011	-	1	-	8,2	1,8	15,5
252176-П29	3724	-	1	1	10,2	1,9	18
252177-П29	1108	2	-	-	12,3	2,2	21
252273-П29	6105	4	4	4	5,2	6,6	12
	6305	1	1	1			

**Шайбы пружинные зубчатые с наружными зубцами**  
**Spring Washers with Outer Teeth**

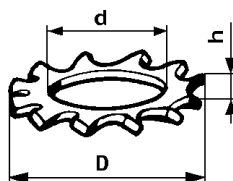

252234-П29	1108	-	-	1	6,2	0,6	12,2
	3724	1	1	1			
	6306	2	2	2			
	8101	1	1	1			
252235-П29	6306	4	4	4	8,4	2,2	14
252236-П29	3743	4	4	4	10,5	2,5	17



1	2	3	4	5	6	7	8
252237-П8	1601	6	-	-	12,5	2,2	20
252239-П29	1602	1	1	1	16	2,6	28
	3506	4	4	4			
	3508	2	2	2			
	3743	2	2	2			
293270-П29	3724	1	-	-	9,8	1	23
293554-П29	1005	1	1	-	28	1	43
1/06157/71	3743	4	4	4	10,6	1	18,3

**Шайбы зубчатые упругие с большой плоскостью опоры**  
**Toothed Elastic Washers with Oversized Outside Diameter**

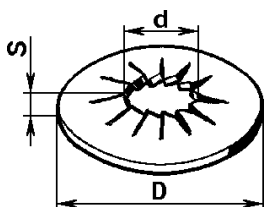

1/25990/71	8202	12	12	12	6	1,4	14
------------	------	----	----	----	---	-----	----

**Шайба пружинная зубчатая коническая с наружными зубцами**  
**Spring Taper Washer with Outer Teeth**

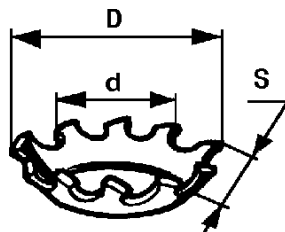

252262-П29	3712	4	4	4	5,2	2,5	9,5
	3726	4	4	4			
	8201	2	2	2			
252263-П29	5202	6	6	6	6,2	3,2	10,8
	6105	24	24	24			
	6305	5	5	5			
1/26068/71	6105	16	16	16	6,2	3,2	10,8
	5202	6	6	6			

**Шайбы специальные**  
**Special Washers**

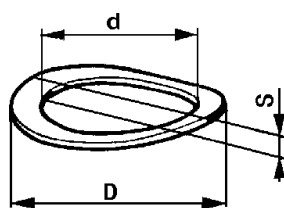

293228-П2	8406	2	2	2	6,2	0,8	9
293272-П2	6105	8	8	8	8,5	1	10

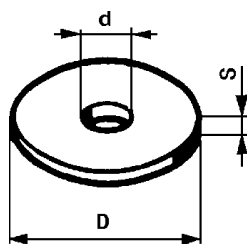

293309-П8	1008	3	-	-	10,5	4,5	26
-----------	------	---	---	---	------	-----	----

1	2	3	4	5	6	7	8
355255-П 356251-П4	1109 2912	6 2	- 2	- 2	4,1 15	1,5 5	10,5 54

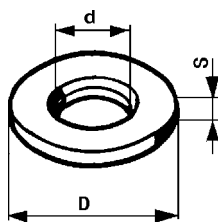

356252-П4	3105 2912	-/1* 2	-/1* 2	-/1* 2	25,5	5	54
-----------	--------------	-----------	-----------	-----------	------	---	----

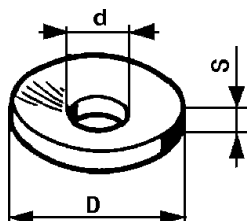

293205-П29	3716	4	4	4	18	5,5	2
------------	------	---	---	---	----	-----	---

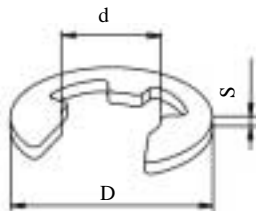

293596	1105	1	-	1	9,2	2	18
--------	------	---	---	---	-----	---	----

### ЗАКЛЕПКИ RIVETS

Обозначение Designation	подгруппы, где применяется Subgroup No.	Количество на подгруппу Qty per subgroup			Размеры, мм Dimensions, mm		
		УАЗ-31519	УАЗ-315195	УАЗ-315143	d	H	l
1	2	3	4	5	6	7	8

### Заклепки с полукруглой головкой Round-Head Rivets

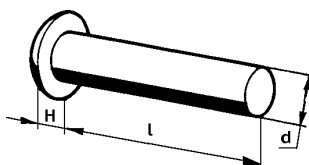

252542-П29	3708	4	-	-	3	2	10
252591-П8	3706	2	-	-	5	3	10
252594-П29	6106	4	4	4	5	3	16

### Заклепки полупустотелые с полукруглой головкой Half-Hollow Round-Head Rivets

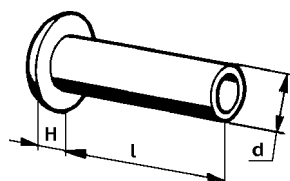

255063-П29	1601	2	2	2	4	1,6	8
------------	------	---	---	---	---	-----	---

1	2	3	4	5	6	7	8
255120-П29	1101	10	10	10	5	2	9
	5107	6	6	6			
255123-П29+	1101	10	10	10	5	2	12

**Заклепка с потайной головкой  
Countersunk Rivet**

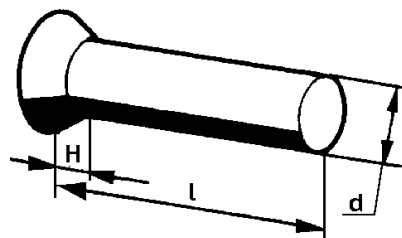

257039-П	2902	6	6	6	10	4	26
	2912	8	8	8			
256834-П	2912	4	4	4	10	4	16

**Заклепки полустопельные с потайной головкой  
Half-Hollow Countersunk Rivets**

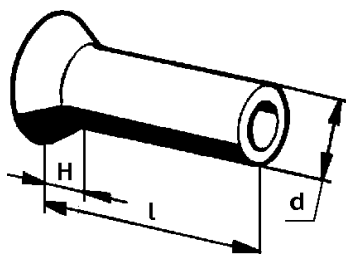

255776-П29	6002	12	12	12	5	1,5	9
293907-П	1601	12	-	-	4	1,5	6
293913-П	1601	12	-	-	4	1,2	7

**Заклепка с плоской головкой  
Flat-Head Rivet**

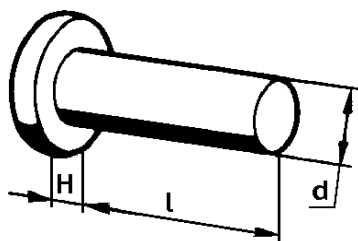

253863-П	1601	12	-	-	4	1,4	5
----------	------	----	---	---	---	-----	---

**Заклепки разводные с полукруглой низкой головкой  
Brazier-Head Rivets**

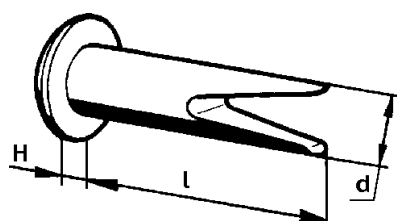

256316-П29	8401	12	12	12	3	1,2	12
	8402	6	6	6			

1	2	3	4	5	6	7	8
---	---	---	---	---	---	---	---

**Заклепка специальная  
Special Rivet**

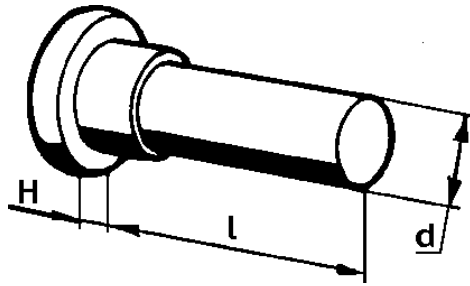

294374-П29                      5304                      1                      1                      1                      82,5                      16

Обозначение Designation	подгруппы, где применяется Subgroup No.	Количество на подгруппу Qty per subgroup			Размеры, мм Dimensions, mm						
		УАЗ-31519	УАЗ-315195	УАЗ-315143	d	d <sub>1</sub>	d <sub>2</sub>	D	H	l	l <sub>1</sub>

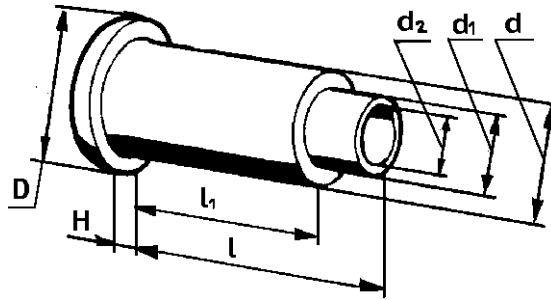

352901-П8                      8406                      1                      1                      1                      12                      9                      6                      18                      4                      16                      6  
352907-П                      3706                      1                      -                      -                      14                      10                      8                      20                      6                      24                      20

Обозначение Designation	подгруппы, где применяется Subgroup No.	Количество на подгруппу Qty per subgroup			Размеры, мм Dimensions, mm			
		УАЗ-31519	УАЗ-315195	УАЗ-315143	d	D	l	L

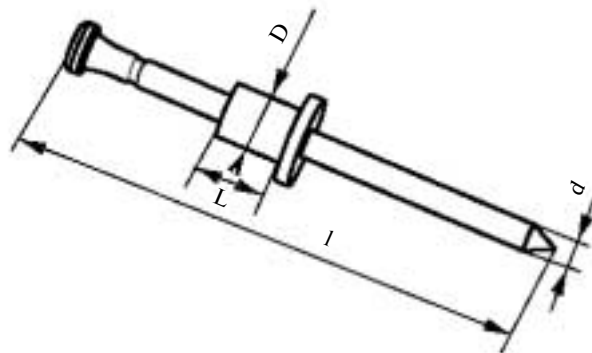

1/28400/90                      6113                      34                      34                      34                      2                      4                      45                      7  
6213                      34                      34                      34

## ШПЛИНТЫ COTTERS

Обозначение Designation	подгруппы, где применяется Subgroup No.	Количество на подгруппу Qty per subgroup			Размеры, мм Dimensions, mm	
		УАЗ-31519	УАЗ-315195	УАЗ-315143	d	l
1	2	3	4	5	6	7

### Шплинты-проволока Wire Cotters

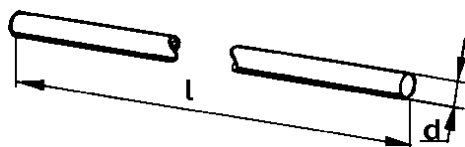

258224-П29	1602	1	1	1	0,8	150
258228-П8	3510	1	1	1	0,8	250
258252-П29	1302	2	2	2	1,2	150

### Шплинты стяжные Contraction Cotters

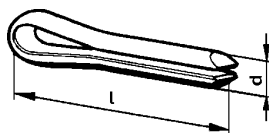

297535-П29	1014	2	-	-	3,5	22
297575-П29	1014	2	-	-	6,4	22
	3506	3	2	3		

### Шплинты разводные Split Cotters

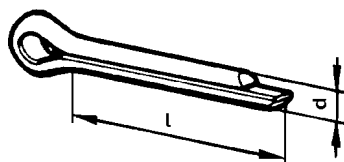

258011-П29	8406	4	4	4	2	10
258012-П29	1108	3	2	2	2	12
	1305	1	-	-		
	6106	4	4	4		
258013-П29	3401	1	1	-	2	16
258038-П29	1007	2	-	-	3,2	16
	1101	4	4	4		
	1602	1	1	1		
	3504	1	1	1		
	3508	5	5	5		
	3510	1	1	1		
	5304	4	4	4		
	5605	4	4	4		
	6870	4	4	4		
	8101	2	2	2		
258039-П29	3510	1	1	1	3,2	20
	3706	2	-	-		
	6870	2	2	2		
258040-П	1011	-	1	-	3,2	25
258040-П29	2912	2	2	2	3,2	25
	3105	-/1*	-/1*	-/1*		
	3414	4	4	4		
	5604	3	3	3		
	5606	1	1	1		
258054-П29	1602	1	1	1	4	32
	2909	2	2	2		
	3504	1	1	1		
	3508	2	2	2		
258222-П	1306	-	1	-	8,8	100

Обозначение Designation	подгруппы, где применяется Subgroup No.	Количество на подгруппу Qty per subgroup			Размеры, мм Dimensions, mm	
		УАЗ-31519	УАЗ-315195	УАЗ-315143	d	l
1	2	3	4	5	6	7

### ШТИФТЫ SET PINS

#### Штифты цилиндрические Round Set Pins

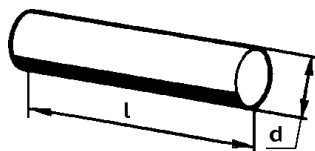

258599	1016	1	-	-	3	12
258611	1002	2	-	-	4	10
258615	1011	1	-	-	4	2
258617	1016	2	-	-	4	25
258617-П	1702	1	1	1	4	25
258623-П29	3401	-	-	1	5	8

#### Штифт с канавкой Grooved Set Pin

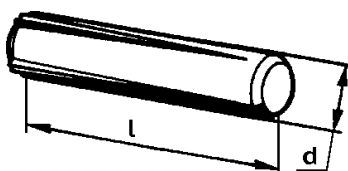

258937-П	1011	1	-	-	4	22
----------	------	---	---	---	---	----

Обозначение Designation	подгруппы, где применяется Subgroup No.	Количество на подгруппу Qty per subgroup			Размеры, мм Dimensions, mm		
		УАЗ-31519	УАЗ-315195	УАЗ-315143	d	l	l <sub>1</sub>
1	2	3	4	5	6	7	8

#### Штифт специальный Special Set Pin

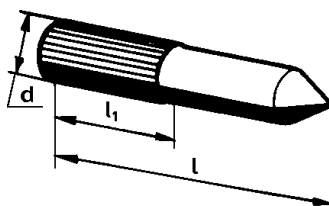

295128-П	1601	-	2	-	-	18	13
295342-П8	1002	1	-	-	4,35	20	10

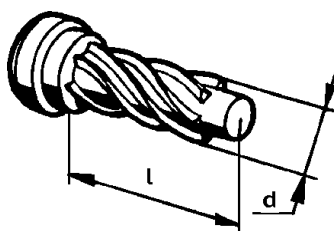

292374-П8	3507	1	1	1	3,0	9	-
-----------	------	---	---	---	-----	---	---

## ПАЛЬЦЫ PINS

Обозначение Designation	подгруппы, где применяется Subgroup No.	Количество на подгруппу Qty per subgroup			Размеры, мм Dimensions, mm		
		УАЗ-31519	УАЗ-315195	УАЗ-315143	d	H	l
1	2	3	4	5	6	7	8

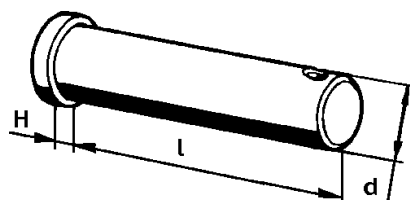

260011-П29	6106	4	4	4	6	2	18
	8406	2	2	2			
260018-П29	8406	2	2	2	6	2	28
260031-П29	3508	1	1	1	8	2,2	18
260033-П	3508	1	1	1	8	2,5	22
260034-П29	3508	1	1	1	8	2,5	25
260045-П29	1101	4	4	4	8	2,5	55
	5604	3	3	3			
260048-П29	5605	4	4	4	8	2,5	70
260056-П29	1602	1	1	1	10	3	25
	3510	1	1	1			
260062-П29	6870	4	4	4	10	3	40
260092-П29	6870	2	2	2	12	3,5	48

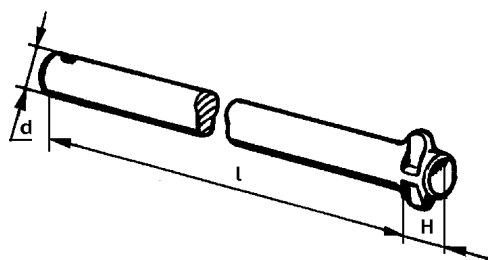

353700-П29	8101	2	2	2	8	7	157
------------	------	---	---	---	---	---	-----

## ЗАГЛУШКИ STOPPERS

Обозначение Designation	подгруппы, где применяется Subgroup No.	Количество на подгруппу Qty per subgroup			Размеры, мм Dimensions, mm	
		УАЗ-31519	УАЗ-315195	УАЗ-315143	D	S
1	2	3	4	5	6	7

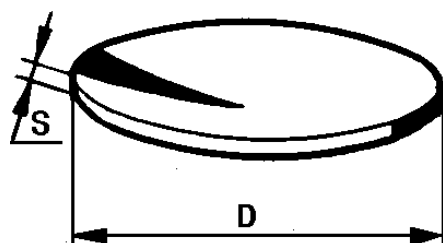

260305-П29	1802	2	2	2	16	1,4-1,5
260306-П29	1702	4	4	4	18	1,4-1,5
260308-П29	3501	4	4	4	22	1,6-1,8
260316	2201	1	1	1	40	2
	2203	1	1	1		
260325-П29	1802	1	1	1	65	2
296997-П29	1002	1	-	-	55	2

## ШПОНКИ KEYS

Обозначение Designation	подгруппы, где применяется Subgroup No.	Количество на подгруппу Qty per subgroup			Размеры, мм Dimensions, mm		
		УАЗ-31519	УАЗ-315195	УАЗ-315143	d	b	h

### Шпонки сегментные Circular Keys

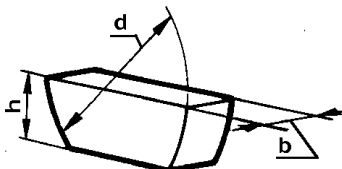

45 9824 0257	1011	-	1	-	16	3	6,5
45 9824 0264	1006	1	-	-	22	5	9,5
45 9824 0267	1005	1	1	-	24	6	10

Обозначение Designation	подгруппы, где применяется Subgroup No.	Количество на подгруппу Qty per subgroup			Размеры, мм Dimensions, mm		
		УАЗ-31519	УАЗ-315195	УАЗ-315143	b	h	l

### Шпонка призматическая Prismatic Key

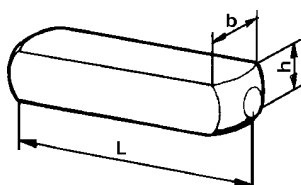

296144-П	1005	1	1	1	8	6	28
----------	------	---	---	---	---	---	----

## ПРОБКИ PLUGS

Обозначение Designation	подгруппы, где применяется Subgroup No.	Количество на подгруппу Qty per subgroup			Размеры, мм Dimensions, mm				
		УАЗ-31519	УАЗ-315195	УАЗ-315143	D	S	H	h	L
1	2	3	4	5	6	7	8	9	10

### Пробки конические с углублением в головке Taper Plugs with Recess in Head

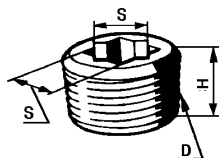

A-24457-A	3401	-	-	1	K1/2"	10	14	-	-
-----------	------	---	---	---	-------	----	----	---	---

### Пробки конические со шлицем Taper Plugs with Slot

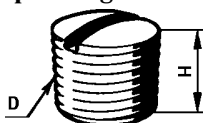

262531-П8	1002	1	-	-	КГ 1/8"	-	9	-	-
296562-П8	1009	-	1	-	КГ 1/4"	-	-	-	-
296563*	1008	1	-	-	К3/8"	-	-	-	-
296563-П	1002	2	-	-	К3/8"	-	-	-	-
296563-П29	1002	-	2	-	К3/8"	-	-	-	-



1	2	3	4	5	6	7	8	9	10
---	---	---	---	---	---	---	---	---	----

**Пробки конические с шестигранной головкой**  
**Hex-Head Taper Plugs**

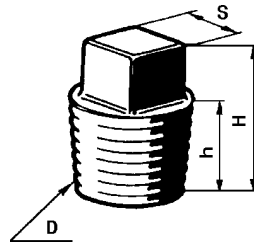

252542-П29	1301	1	1	-	K1/4"	14	6	-	15
262541-П29	1002	-	1	-	KГ1/8"	12	4,5	-	10,5
	1006	-	2	-					
353052-П29	1002	-	1	-	K1/4"	14	6	-	12

**Пробки специальные с шестигранной головкой**  
**Hex-Head Special Plugs**

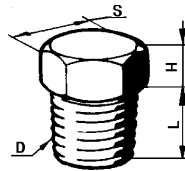

290872-П29	1105	1	-	1	M12	19	5	-	12
296494-П8	1009	1	-	-	M18x1,5	24	6	-	12
296499-П29	1002	-	1	-	M18x1,5	24	6	-	12

**Пробка резьбовая коническая с внутренним шестигранником**  
**Threaded Taper Plug with Hex Recess**

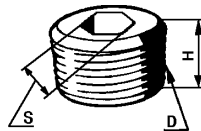

296576-П29	1002	-	1	-	KГ 1/2"	12	15	-	-
	1701	1	1	1					
	3401	-	2	-					
1/43253/01	1802	1	1	1	M22x1,5	12	13	9	-
	2301	1	1	1					
	2401	1	1	1					

**ПРЕСС-МАСЛЕНКИ**  
**PRESSURE LUBRICATORS**

Обозначение Designation	подгруппы, где применяется Subgroup No.	Количество на подгруппу Qty per subgroup			Размеры, мм Dimensions, mm			
		УА3-31519	УА3-315195	УА3-315143	К	Н	h	S
1	2	3	4	5	6	7	8	9

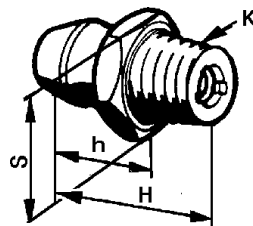

1.1.Ц6	6106	8	8	8	M6	13	8	8
--------	------	---	---	---	----	----	---	---

1	2	3	4	5	6	7	8	9
45 9167 4063	2201	3	3	3	M6	13	8	8
	2203	3	3	3				
	3414	4	4	4				

### ШТУЦЕРЫ UNIONS

Обозначение Designation	подгруппы, где применяется Subgroup No.	Количество на подгруппу Qty per subgroup			Размеры, мм Dimensions, mm			
		УАЗ-31519	УАЗ-315195	УАЗ-315143	D	dL	h	
1	2	3	4	5	6	7	8	9

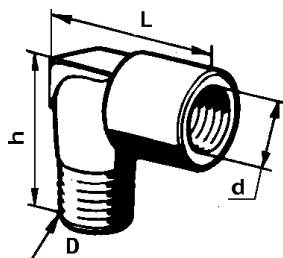

354801	1012	1	1	1	1/4"	M14x1,5	32	39,5
354801-П	1105	1	-	1	1/4"	M14x1,5	32	39,5

### ПРЯЖКИ ХОМУТИКОВ BUCKLES

Обозначение Designation	подгруппы, где применяется Subgroup No.	Количество на подгруппу Qty per subgroup			Размеры, мм Dimensions, mm		
		УАЗ-31519	УАЗ-315195	УАЗ-315143	d	b	l
1	2	3	4	5	6	7	8

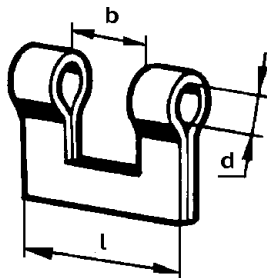

297540-П29	1014	2	-	-	3,3	5,5	12
297580-П29	1014	2	-	-	6,5	10,5	17
	3506	3	2	3			

### ЛЕНТЫ СТЯЖНЫЕ CONTRACTION BANDS

Обозначение Designation	подгруппы, где применяется Subgroup No.	Количество на подгруппу Qty per subgroup			Размеры, мм Dimensions, mm	
		УАЗ-31519	УАЗ-315195	УАЗ-315143	B	L
1	2	3	4	5	6	7

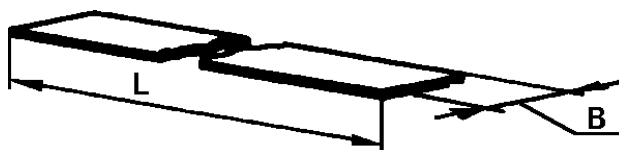

297584-П29	1014	2	-	-	10	235
297594-П29	3506	3	2	3	10	580

### КЛАПАНЫ VALVES

Обозначение Designation	подгруппы, где применяется Subgroup No.	Количество на подгруппу Qty per subgroup			Размеры, мм Dimensions, mm	
		УАЗ-31519	УАЗ-315195	УАЗ-315143	B	L
1	2	3	4	5	6	7

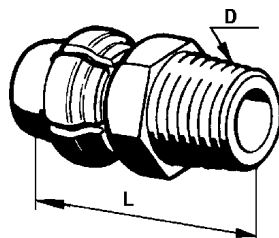

308387-П	1802	1	1	1	K1/8"	27
	2300	1	1	1		
	2400	1	1	1		

### ПИСТОН STAPEL

Обозначение Designation	подгруппы, где применяется Subgroup No.	Количество на подгруппу Qty per subgroup			Размеры, мм Dimensions, mm			
		УАЗ-31519	УАЗ-315195	УАЗ-315143	D	d	L	h
1	2	3	4	5	6	7	8	9

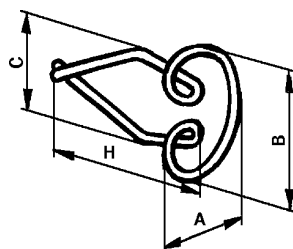

298322-П	8403	18	18	18	8	13	12,5	22
----------	------	----	----	----	---	----	------	----